

A HANDBOOK FOR VALUE CHAIN RESEARCH

Prepared for the IDRC by

Raphael Kaplinsky and Mike Morris*

We are grateful to colleagues in both our individual institutions and in the Spreading the Gains from Globalisation Network (particularly those participating in the Bellagio Workshop in September 2000) for discussions around many of the issues covered in this Handbook and also to Stephanie Barrientos, Jayne Smith and Justin Barnes.

An Important Health Warning

or

A Guide for Using this Handbook

Lest anyone feel overwhelmed by the depth of detail in this Handbook, especially with respect to the sections on methodology, we would like to emphasise at the outset: this Handbook is not meant to be used or read as a comprehensive step by step process that has to be followed in order to undertake a value chain analysis. We know of no value chain analysis that has comprehensively covered all the aspects dealt with in the following pages, and certainly not in the methodologically sequential Handbook set out below. Indeed to try and do so in this form would be methodologically overwhelming, and would certainly bore any reader of such an analysis to tears.

Our intention in producing a Handbook on researching value chains is to try and comprehensively cover as many aspects of value chain analysis as possible so as to allow researchers to dip in and utilise what is relevant and where it is appropriate. It is not an attempt to restrict researchers within a methodological strait-jacket, but rather to free them to use whatever tools are deemed suitable from the variety presented below.

The text below attempts to cover the broad terrain of researching value chains, and hence spans the contextually relevant, the conceptually abstract, the methodologically particular, and the policy relevant. Part 3 on Methodology can therefore be read in a number of ways: as a form of expanding the conceptual issues raised in Part 1 on Basic Definitions and Part 2 on Analytic Constructs; or as an array of possible technical tools, *some* of which may be usefully adopted and methodologically applied either partially or fully depending on circumstances; or whole parts can be skipped and not read at all.

Indeed, apart from using it as a research tool, it is not even our intention that everyone should read the Handbook in the way one would go through a (good) novel – sequentially, and from cover to cover. We therefore urge readers to use their common sense and treat it as one does an edited book, or researchers to read it in the same way one reads a mechanics manual for finding out about one's car. Treat the contents page as an à la carte menu, read the bits that are interesting, take what is relevant for whatever research task is at hand, and skim what is not relevant.

Contents

1	<u>INTRODUCTION</u>	1
	<u>PART 1: BASIC DEFINITIONS AND CONTEXT</u>	4
2	<u>WHAT IS A VALUE CHAIN?</u>	4
2.1	<u>DEFINITIONS</u>	4
2.1.1	<i>The Simple Value Chain</i>	4
2.1.2	<i>The extended value chain</i>	4
2.1.3	<i>One or many value chains</i>	6
2.1.4	<i>One or many labels?</i>	6
3	<u>WHY IS VALUE CHAIN ANALYSIS IMPORTANT?</u>	9
3.1	<u>THE GROWING IMPORTANCE OF SYSTEMIC COMPETITIVENESS</u>	9
3.2	<u>IS EFFICIENT PRODUCTION ENOUGH?</u>	12
3.2.1	<i>Making the best of globalisation</i>	14
3.2.2	<i>The march of globalisation</i>	15
3.2.3	<i>Winners and losers from globalisation</i>	16
3.2.4	<i>Making the best of globalisation</i>	18
3.2.5	<i>Making the worst of globalisation</i>	18
3.2.6	<i>How does value chain research inform this debate on globalisation?</i> 22	
	<u>PART 2: KEY ANALYTICAL CONSTRUCTS</u>	24
4	<u>IS THE VALUE CHAIN A HEURISTIC DEVICE OR AN ANALYTICAL TOOL?</u>	25
4.1	<u>THREE KEY ELEMENTS OF VALUE CHAIN ANALYSIS</u>	25
4.1.1	<i>Barriers to entry and rent</i>	25
4.1.2	<i>Governance</i>	29
4.1.3	<i>Different types of value chains</i>	32
5	<u>VALUE CHAINS, INNOVATION AND UPGRADING</u>	37
	<u>DIFFERENT TYPES OF UPGRADING</u>	37
6	<u>VALUE CHAIN ANALYSIS AND THE DETERMINANTS OF INCOME DISTRIBUTION</u>	41
6.1	<u>MAPPING DISTRIBUTIONAL OUTCOMES IN THE VALUE CHAIN</u>	41
6.2	<u>UNDERSTANDING THE DETERMINANTS OF INCOME DISTRIBUTION IN VALUE CHAINS</u>	43
6.3	<u>LEVERS OF POWER IN VALUE CHAIN DYNAMICS</u>	44
7	<u>HOW DOES VALUE CHAIN ANALYSIS DIFFER FROM CONVENTIONAL INDUSTRY STUDIES AND FROM WHAT SOCIAL SCIENTISTS (AND ESPECIALLY ECONOMISTS) NORMALLY DO?</u>	46
	<u>PART 3: A METHODOLOGY FOR UNDERTAKING VALUE CHAIN RESEARCH</u>	49
8	<u>THE POINT OF ENTRY FOR VALUE CHAIN ANALYSIS</u>	50

<u>9</u>	<u>MAPPING VALUE CHAINS</u>	53
<u>10</u>	<u>PRODUCT SEGMENTS AND CRITICAL SUCCESS FACTOR'S IN FINAL MARKETS</u>	55
<u>11</u>	<u>HOW PRODUCERS ACCESS FINAL MARKETS</u>	60
<u>12</u>	<u>BENCHMARKING PRODUCTION EFFICIENCY</u>	63
<u>13</u>	<u>GOVERNANCE OF VALUE CHAINS</u>	66
<u>13.1</u>	<u>“GOVERNANCE”: AN OVERVIEW</u>	67
<u>13.2</u>	<u>RULE-MAKING AND RULE KEEPING</u>	68
<u>13.3</u>	<u>TYPES OF RULES</u>	68
<u>13.4</u>	<u>INTERNAL AND EXTERNAL RULE-SETTING</u>	69
<u>13.5</u>	<u>SANCTIONS IN THE RULE-REGIME</u>	72
<u>13.6</u>	<u>THE LEGITIMACY OF POWER</u>	73
<u>13.7</u>	<u>THE PERVASIVENESS OF THE RULE-REGIME</u>	74
<u>14</u>	<u>UPGRADING IN VALUE CHAINS</u>	76
<u>14.1</u>	<u>DISTRIBUTIONAL ISSUES</u>	78
<u>14.2</u>	<u>RENTS AND BARRIERS TO ENTRY</u>	79
<u>14.3</u>	<u>THE UNIT OF ACCOUNT, THAT IS WHICH CURRENCY IS UTILISED TO MEASURE INCOME</u>	81
<u>14.4</u>	<u>IN WHAT CIRCUMSTANCES TURNOVER AND VALUE ADDED DATA ILLUMINATE THE ANALYSIS</u>	84
<u>14.5</u>	<u>HOW IS PROFITABILITY TO BE MEASURED, AND ARE PROFITS AN APPROPRIATE MEASURE OF DISTRIBUTIONAL OUTCOMES?</u>	86
<u>14.6</u>	<u>THE LOCATIONAL DIMENSIONS OF INCOME DISTRIBUTION</u>	90
<u>14.7</u>	<u>DECOMPOSING INCOME STREAMS - CLASS, GENDER, ETHNICITY, AND INCOME GROUPS</u>	91
<u>15</u>	<u>INCORPORATING A KNOWLEDGE FOCUS INTO VALUE CHAIN ANALYSIS</u>	94
<u>16</u>	<u>HOW DO SMES FIT INTO GLOBAL VALUE CHAINS?</u>	97
<u>17</u>	<u>CONCLUSION AND POLICY IMPLICATIONS</u>	101
	<u>REFERENCES</u>	105

1 INTRODUCTION

For many of the world's population, the growing integration of the global economy has provided the opportunity for substantial economic and income growth. The fact that globalisation in this new era has also come to include the production of manufactured components linked and coordinated on a global scale has opened significant opportunities for developing countries and regions. For the citizens of the developing world it contains the promise of potentially increasing the rate and scope of industrial growth and the upgrading of their manufacturing and service activities. They understand that without sustained economic growth in their countries there is little hope of addressing the poverty and inequality that is so pervasive. They therefore view the growing integration of the global economy as an opportunity for entering into a new era of economic and industrial growth, reflected not only in the possibility of reaping higher incomes, but also in the improved availability of better quality and increasingly differentiated final products.

However, at the same time, globalisation has had its dark side. There has been an increasing tendency towards growing unequalisation within and between countries and a growing incidence in the absolute levels of poverty, not just in poor countries. These positive and negative attributes of globalisation have been experienced at a number of different levels – the individual, the household, the firm, the town, the region, the sector and the nation. The distributional pattern emerging in recent decades of globalisation is thus simultaneously heterogeneous and complex.

If those who had lost from globalisation had been confined to the non-participants, the policy implications would be clear – take every step to be an active participant in global production and trade. However, the challenge is much more daunting than this, since the losers include many of those who have participated actively in the process of global integration. Hence, there is a need to manage the mode of insertion into the global economy, to ensure that incomes are not reduced or further polarised.

Four central questions arise from these observations:

- why has the participation in global product markets and the geographical dispersal of economic activity not led to a concomitant spread in social and economic benefits for those newly integrated populations? Or, to put it another way, why is there a disjuncture between high levels of economic integration into global product markets and the extent to which countries and people actually gain from globalisation?
- to what extent is it possible to identify a causal link between globalisation and inequality?
- what can be done to arrest the unequalising tendencies of globalisation?
- how can the factors and processes facilitating the upgrading of globally dispersed manufacturing activities so as to provide for raised living standards be analysed?

These related questions have important methodological implications – what is the best way to generate the information required to document these developments in

production and appropriation, and how can we identify policy instruments which might arrest, and perhaps partially reverse these developments?¹.

Value chain analysis provides important insights into these four issues. Of course it does not tell the whole story, which to be complete would also have to address macroeconomic issues (particularly capital flows and their volatility), political issues (particularly the factors determining the rate and productivity of investment) and the determinants of social capital. But value chain analysis, which focuses on the dynamics of inter-linkages within the productive sector, especially the way in which firms and countries are globally integrated, takes us a great deal further than traditional modes of economic and social analysis.

Value chain analysis overcomes a number of important weaknesses of traditional sectoral analysis which tends to be static and suffers from the weakness of its own bounded parameters. For in restricting itself to sectoral analysis, it struggles to deal with dynamic linkages between productive activities that go beyond that particular sector, whether they are of an inter-sectoral nature or between formal and informal sector activities. Value chain also goes beyond the firm-specific analysis of much of the innovation literature. By its concentration on inter linkages it allows for an easy uncovering of the dynamic flow of economic, organisational and coercive activities between producers within different sectors even on a global scale. For example informal sector scrap metal collectors in South Africa are inextricably linked to a global export trade. They bring scrap metal in old trolleys directly to shipping agents who pay them London spot prices and transfer the scrap immediately to ships for export to iron and steel furnaces across the globe. Furthermore the notion of organisational inter-linkages underpinning value chain analysis makes it easy to analyse the inter-relationship between formal and informal work (with workers, particularly in developing countries, moving often seamlessly from one to the other) and not to view them as disconnected spheres of activity.

Furthermore value chain analysis is particularly useful for new producers – including poor producers and poor countries – who are trying to enter global markets in a manner which would provide for sustainable income growth. Finally value chain analysis is also useful as an analytical tool in understanding the policy environment which provides for the efficient allocation of resources within the domestic economy, notwithstanding its primary use thus far as an analytic tool for understanding the way in which firms and countries participate in the global economy.

The objective of this Handbook is to assist researchers in formulating and executing value chain research, particularly with a view to framing a policy environment which will assist poor producers and poor countries to participate effectively in the global economy. Aside from this introductory chapter, the main body of the Handbook is divided into three distinct parts, each comprising a number of chapters:

¹ An associated methodological issue which is not covered in this Handbook is whether to use action research methods, that is to directly involve stakeholders in the definition and execution of the research project. This both enhances the quality of the information which is collected and makes it more likely that the research output will have an impact on policy. However, action research may not be easy to execute and suffers from the problem of the researchers not being adequately objective in their analysis and data collection. For an example of a value chain action based research programme, see Morris (2001).

- Part 1 provides a broad overview, defining value chains, introducing key concepts and discussing the contribution of value chain analysis as an analytical and policy tool.
- Part 2 is concerned with underlying theoretical constructs in value chain analysis.
- In Part 3 we lay out a methodology for undertaking value chain research

The Handbook ends with a concluding chapter which provides some pointers to the policy implications of value chain analysis.

This Handbook is targeted at both an academic and a practitioner level. We have therefore attempted to produce this text in an accessible form. References have consequently been generally excluded from the main text and are instead included (with Guide Questions) at various points in the text.

Our concern is to facilitate research and policy action which uses value chain analysis. Readers who have suggestions to make for adding to or improving this Handbook should email these to:

Raphael Kaplinsky at kaplinsky@ids.ac.uk, Institute of Development Studies at the University of Sussex and Centre for Research in Innovation Management at the University of Brighton, or to Mike Morris at morrism@nu.ac.za, School of Development Studies, University of Natal.

And hopefully these will be pasted into the web-sites of our respective institutions (www.ids.ac.uk/global, www.centrim.bus.bton.ac.uk/ and www.nu.ac.za/csds)

PART 1: BASIC DEFINITIONS AND CONTEXT

2 WHAT IS A VALUE CHAIN?

2.1 Definitions

2.1.1 The Simple Value Chain

The *value chain* describes the full range of activities which are required to bring a product or service from conception, through the different phases of production (involving a combination of physical transformation and the input of various producer services), delivery to final consumers, and final disposal after use. Considered in its general form, it takes the shape as described in Figure 1. As can be seen from this, production *per se* is only one of a number of value added *links*. Moreover, there are ranges of activities within each link of the chain. Although often depicted as a vertical chain, intra-chain linkages are most often of a two-way nature – for example, specialised design agencies not only influence the nature of the production process and marketing, but are in turn influenced by the constraints in these downstream links in the chain.

Figure 1: Four links in a simple value chain

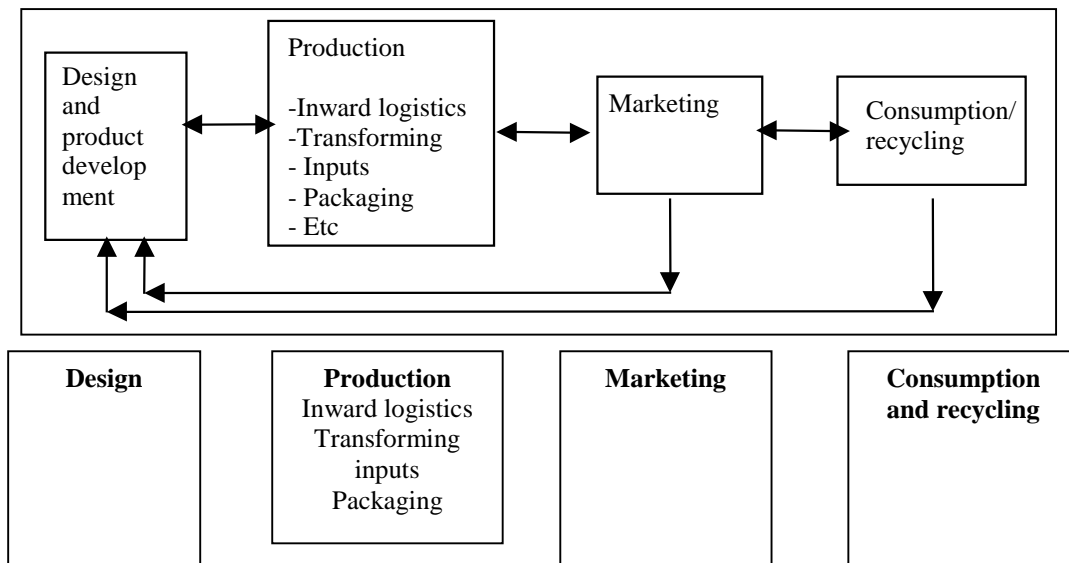

2.1.2 The extended value chain

In the real world, of course, value chains are much more complex than this. For one thing, there tend to be many more links in the chain. Take, for example, the case of the furniture industry (Figure 2). This involves the provision of seed inputs, chemicals, equipment and water for the forestry sector. Cut logs pass to the sawmill sector which gets its primary inputs from the machinery sector. From there, sawn timber moves to the furniture manufacturers who, in turn, obtain inputs from the machinery, adhesives and paint industries and also draw on design and branding skills from the service sector. Depending on which market is served, the furniture then passes through various intermediary stages until it reaches the final customer, who after use, consigns the furniture for recycling.

Figure 2: The forestry, timber and furniture value chain

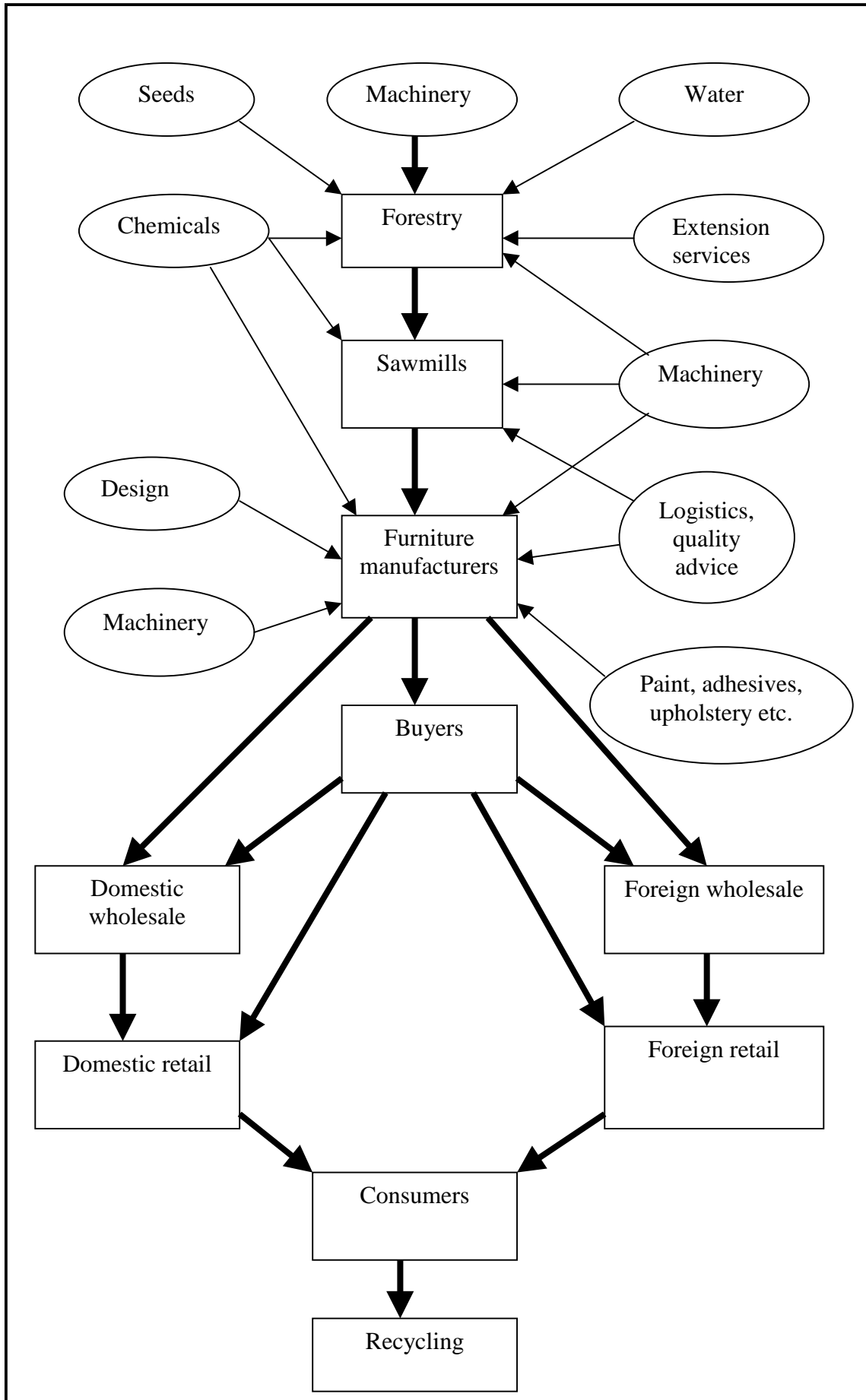

2.1.3 One or many value chains

In addition to the manifold links in a value chain, typically intermediary producers in a particular value chain may feed into a number of different value chains (Figure 3). In some cases, these alternative value chains may absorb only a small share of their output; in other cases, there may be an equal spread of customers. But the share of sales at a particular point in time may not capture the full story – the dynamics of a particular market or technology may mean that a relatively small (or large) customer/supplier may become a relatively large (small) customer/supplier in the future. Furthermore the share of sales may obscure the crucial role that a particular supplier controlling a key core technology or input (which may be a relatively small part of its output) has on the rest of the value chain.

Figure 3: One or many value chains?

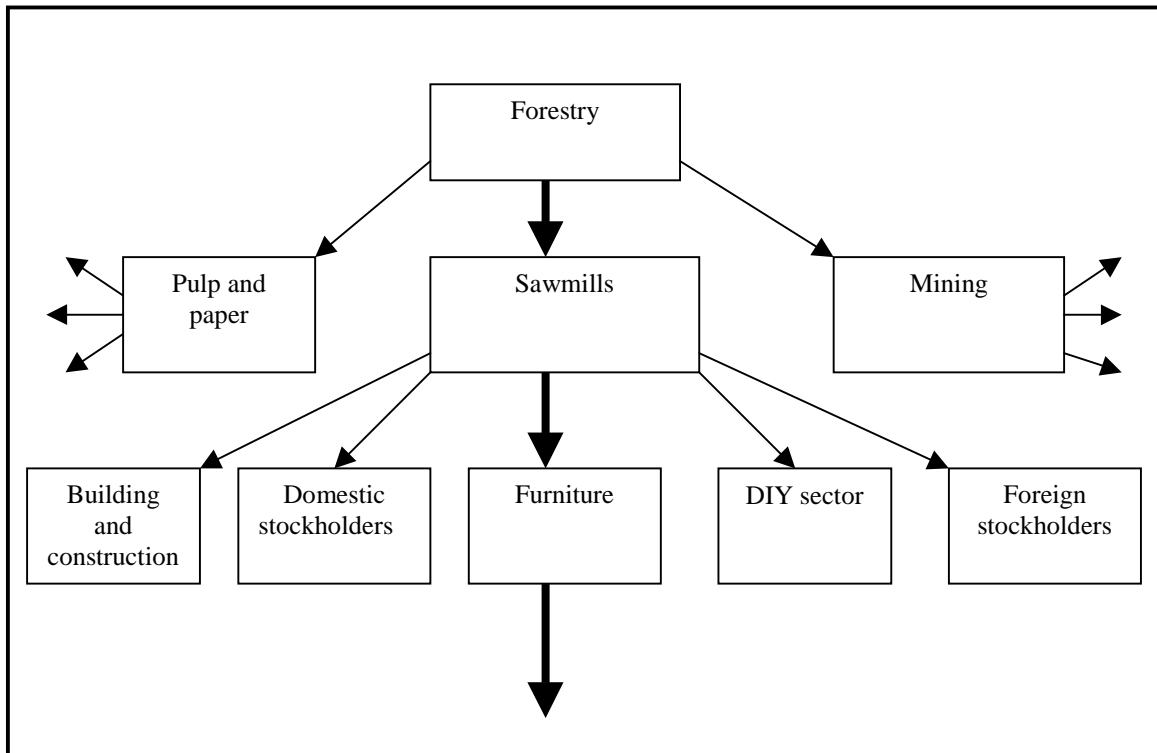

2.1.4 One or many labels?

There is a considerable overlap between the concept of a value chain and similar concepts used in other contexts. One important source of confusion – particularly in earlier years before the value chain as outlined above became increasingly widespread in the research and policy domain – was one of nomenclature and arose from the work of Michael Porter in the mid 1980s. Porter distinguished two important elements of modern value chain analysis:

- The various *activities* which were performed in particular links in the chain. Here he drew the distinction between different stages of the process of supply (inbound logistics, operations, outbound logistics, marketing and sales, and after sales service), the transformation of these inputs into outputs (production, logistics, quality and continuous improvement processes), and the support services the firm marshals to accomplish this task (strategic planning, human resource

management, technology development and procurement).² The importance of separating out these various functions is that it draws attention away from an exclusive focus on physical transformation.³ As we shall see in later sections of this Handbook, these functions need not be performed within a single link in the chain, but may be provided by other links (for example, by outsourcing). Confusingly, Porter refers to these essentially intra-link activities as the value chain.

- Porter complements this discussion of intra-link functions with the concept of the multi-linked value chain itself, which he refers to as the *value system*. The value system basically extends his idea of the value chain (as described in the previous paragraph) to inter-link linkages, and is the value chain as set out in Figure 1 above.

In essence, therefore, both of these elements in Porter's analysis are subsumed by modern value chain analysis. The primary issue is one of terminological confusion, and this problem is exacerbated by Womack and Jones in their influential work on lean production. They similarly use the phrase *value stream* to refer to what most people (including this Handbook) now call the value chain.

Another concept which is similar in some respects to the value chain is that of the *filiere* (whose literal meaning in French is that of a "thread").⁴ It is used to describe the flow of physical inputs and services in the production of a final product (a good or a service) and, in terms of its concern with quantitative technical relationships, is essentially no different from the picture drawn in Figure 1 or from Porter and Womack and Jones' value stream. French scholars built on analyses of the value added process in US agricultural research to analyses the processes of vertical integration and contract manufacturing in French agriculture during the 1960s. The early *filiere analysis* emphasised local economic multiplier effects of input-output relations between firms and focused on efficiency gains resulting from scale economies, transaction and transport costs etc. It was then applied in French colonial policy on the agricultural sector and, during the 1980s, to industrial policy, particularly in electronics and telecommunications. The later work gave the modern version of *filiere* analysis an additional political economy dimension insofar as it factored in the contributory role of public institutions into what were essentially technical quantitative relationships, thereby bringing it analytically closer to contemporary value chain analysis.⁵ However a *filiere* tended to be viewed as having a static character, reflecting relations at a certain point in time. It does not indicate growing or shrinking flows either of commodity or knowledge, nor the rise and fall of actors. Although there is no conceptual reason why this should have been the case, in general *filiere* analysis has been applied to the domestic value chain, thus stopping at national boundaries.

² The text in brackets in this sentence are the activities listed in the Production link in Figure 1.

³ From this follows the recognition that the greatest value is often added in these support services, and that '[a]lthough value activities are the building blocks of competitive advantage, the value chain is not a collection of independent activities. Value activities are related by linkages within the value chain' (Porter 1985: 48).

⁴ For a historical review of the concept of the *filiere*, see Raikes, Jensen and Ponte (2000).

⁵ See, for example, the IDS/UNDP industrial strategy in the Dominican Republic (IDS/UNDP, 1992), and Bernstein on the South African maize industry (Bernstein, 1996).

Guide Questions 1

- Plot a value chain of one or more sectors, distinguishing between value chains, value links and activities
- What is the difference between value chains, value streams, value systems, filieres and global commodity chains?
- What proportion of output has to be fed into a particular chain for an intermediate supplier to be seen as a member of a particular chain?
- Chart different types of activities and links in a value chain, distinguishing between those which involve physical transformation, and those which reflect service inputs

Further reading

Bernstein, H. (1996) "The Political Economy of the Maize *Filiere*", Journal of Peasant Studies, Vol 23, No 2/3.

Gereffi, G. (1994), "The Organization of Buyer-Driven Global Commodity Chains: How U. S. Retailers Shape Overseas Production Networks", in Gereffi and Korzeniewicz (eds.), Commodity Chains and Global Capitalism, London: Praeger.

Kaplinsky R. (2000), "Spreading the gains from globalisation: What can be learned from value chain analysis?", Journal of Development Studies, Vol. 37, No. 2

Porter M. E (1985), Competitive Advantage: Creating and Sustaining Superior Performance, N. York: The Free Press.

Raikes P., M. Friis-Jensen and S. Ponte (2000), "Global Commodity Chain Analysis and the French *Filière* Approach", Economy and Society.

Womack, James P. and Daniel T Jones (1996), Lean Thinking: Banish Waste and Create Wealth in Your Corporation, N. York: Simon & Schuster

A third concept which has been used to describe the value chain is that of *global commodity chains*, introduced into the literature by Gereffi during the mid-1990s. As we shall see below, Gereffi's contribution has enabled important advances to be made in the analytical and normative usage of the value chain concept, particularly because of its focus on the power relations which are imbedded in value chain analysis. By explicitly focusing on the coordination of globally dispersed, but linked, production systems, Gereffi has shown that many chains are characterised by a dominant party (or sometimes parties) who determine the overall character of the chain, and as lead firm(s) becomes responsible for upgrading activities within individual links and coordinating interaction between the links. This is a role of 'governance', and here a distinction is made between two types of governance: those cases where the coordination is undertaken by buyers ('buyer-driven commodity chains') and those in which producers play the key role ('producer-driven commodity chains').

3 WHY IS VALUE CHAIN ANALYSIS IMPORTANT?

There are three main sets of reasons why value chain analysis is important in this era of rapid globalisation. They are:

- ❑ With the growing division of labour and the global dispersion of the production of components, systemic competitiveness has become increasingly important
- ❑ Efficiency in production is only a necessary condition for successfully penetrating global markets
- ❑ Entry into global markets which allows for sustained income growth – that is, making the best of globalisation - requires an understanding of dynamic factors within the whole value chain

3.1 The growing importance of systemic competitiveness

Adam Smith observed that the division of labour was determined by the extent of the market. By this he meant that small scale markets allowed for little specialisation – the entrepreneur making a small number of chairs employed no-one and undertook all the different tasks that were required in making the final product. But as the market expanded, so it became profitable to employ workers, and to allow each of them to specialise. Smith argued that specialisation of task meant that workers did not waste time picking up and putting down their work-in-progress, and allowed them to concentrate on developing their specific skills. Moreover, it also opened the way to the introduction of mechanisation as simple, repetitive tasks were much easier to mechanise than complex tasks.

From the perspective of the production plant itself, increasing scale meant that the work process could be subdivided into an increasing number of work-stations, and the object of F.W. Taylor's theories on work-organisation was to increase the efficiency of each of these work stations through "scientific management" procedures. This approach towards production organisation dominated from the 1890s until the late 1970s. It even infiltrated the thinking towards the first examples of electronically-automated production processes, where new automated machines were seen as "islands of automation". But, increasingly, the approach towards intra-plant and inter-firm production organisation shifted towards a more systemic focus. In the first place, the application of just-in-time principles to production flow made it obvious that striving towards "island-efficiency" often led to bottlenecks and systemic inefficiency (Box 1). This meant that sometimes it was important to tolerate "inefficiency" at a particular point in the production line to achieve plant-efficiency. For example, the objective of reducing inventories (which we now know is pivotal in achieving competitive production) means that individual workers should only continue working if the next stage in the production process required materials; if not, they should stop and avoid "pushing" additional work-in-progress materials on to the next worker which would only lead to the build-up of work-in-progress. In the process, the individual worker might become less "productive", but the whole system will be operating with lower inventories, greater responsiveness and higher levels of quality.

A second reason promoting systemic thinking was that the use of electronics-based automation technologies in different parts of the plant led to the possibility of coordinating the different machines through EDI (electronic data interchange). And, finally, the need to get products to the market more quickly meant that the historical divide between development, design, production and marketing had to be bridged. Rapid product innovation required that these formerly distinct functions work together in a process of “parallel/concurrent” engineering.

This systemic approach towards intra-plant and intra-firm efficiency began to spill over into thinking about inter-firm linkages during the 1980s. Here, two developments were particularly important. First, Toyota in Japan had shown from the late 1970s that the development of just-in-time, total quality management and continuous improvement procedures within the firm might make no discernible difference towards its own competitiveness unless its various tiers of component suppliers – accounting for 60-70 percent of total product costs – adopted similar practices (Box 1). It therefore arranged for its first tier component suppliers to ensure that similar processes were adopted throughout the supply chain. The second major influence here, with its origins in the US, was the development of thinking about core competence. The logic of this is that firms should concentrate on those resources which they possessed which were relatively unique, provided a valuable service to customers and which were difficult to copy, and that they should outsource the remaining competences to other firms in the value chain. This extended the complexity of production, and the consequent need to ensure systemic competitiveness between firms.

Box 1: Lean production

- ❑ Lean Production (also referred to as World Class Manufacturing) has its origins in three sets of linked organisational innovations which were first developed in Japan. These are:
- ❑ Just in time production (JIT), which focuses on pulling rather than pushing inventories through the enterprise, providing materials and products in just the right quantities, at just the right time and in just the right place
- ❑ Total Quality Management (TQM) involves checking quality during rather than at the end of the production process
- ❑ Continuous Improvement (CI) involves the whole labour force participating in a focused programme of incremental changes which adds up to significant and rapid change over time.

Originally developed to further in-plant efficiency, it soon became apparent that their impact would be limited unless in-plant changes were complimented by equivalent changes in the relationship between different links in the value chain.

Further reading

- ❑ The underlying principles and their application in developing countries is described in:
Kaplinsky, R. (1994), Easternisation: The Spread of Japanese Management Techniques to Developing Countries, London: Frank Cass.
- ❑ The techniques used to achieve these ends are discussed in:
Bessant John (1991), Managing Advanced Manufacturing Technology, London, Basil Blackwell.
Schonberger, R J, (1986) World Class Manufacturing: The Lessons of Simplicity Applied, New York: The Free Press.
- ❑ The systemic component of these changes is discussed, with case-studies, in:
Womack, James P. and Daniel T Jones (1996), Lean Thinking: Banish Waste and Create Wealth in Your Corporation, N. York: Simon & Schuster
- ❑ Core competence is discussed in:
Hamel G. and C.K. Prahalad (1994), Competing for the Future, Cambridge Mass, Harvard Business School Press.

Value chain analysis plays a key role in understanding the need and scope for systemic competitiveness. The analysis and identification of core competences will lead the firm to outsource those functions where it has no distinctive competences. Mapping the flow of inputs – goods and services – in the production chain allows each firm to determine who else’s behaviour plays an important role in its success. Then, in those cases where the firm does not internalise much or most of the value

chain in its own operations, its own efforts to upgrade and achieve efficiency will be to little effect. The same challenge is true for national or regional economic management – upgrading the performance of individual firms in a region may have little impact if they are imbedded in a sea of inefficiency.

3.2 Is efficient production enough?

The second reason why value chain analysis is important is that it helps in understanding the advantages and disadvantages of firms and countries specialising in production rather than services, and why the way in which producers are connected to final markets may influence their ability to gain from participating in global markets.

As more and more firms and regions improved their capabilities in the post-war period, particularly in the last two decades of the twentieth century, so low-cost sources of supply grew for buyers procuring on a global stage. In some countries - particularly Mexico, Brazil, Hong Kong, Malaysia, Singapore and Thailand - production was increasingly undertaken by subsidiaries of foreign-owned TNCs. In other cases, production occurred either through foreign licences or by firms who had managed to develop local design and technological capabilities. Many of these producers could meet global price and quality standards, and could supply in adequate volumes. The question was whose production would be utilised?

Trade policies in final markets have played a dominant role here. Despite decades of post-war trade liberalisation, obstacles to the free flow of goods remain, even in the rich countries (Box 2). Sometimes these are tariff-based, but in other cases they reflect complex patterns of quota access. These trade barriers are often region specific – for example, the EU provides preferential access to the ACP countries under the Lomé Convention. But in other cases, notably clothing and textiles, trade is heavily regulated under the International Textile and Clothing Agreement (formerly the MFA, Multifibres Agreement). The EU is also particularly distinctive because of its protective regime against imports of agricultural products.

Box 2: The number of countries still gaining preferential access to the EU

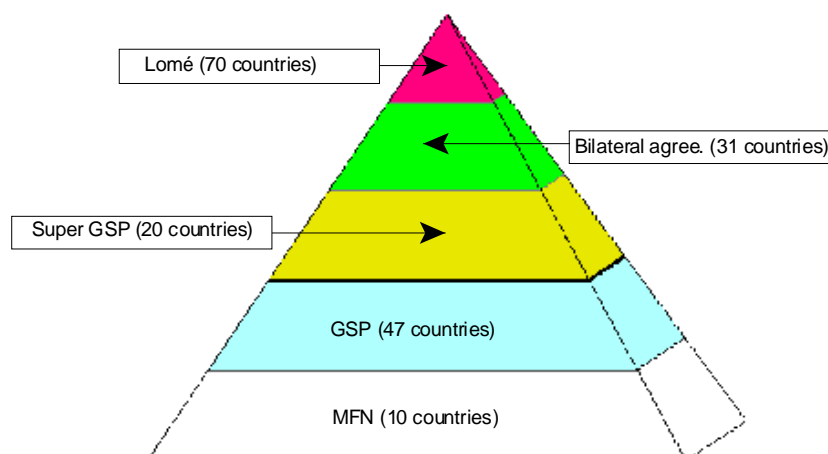

Source: Stevens, C and J. Kennan, (2001), "Food Aid and Trade", in S. Deveraux and S. Maxwell (eds.), Food Security in Sub Saharan Africa, London: ITDG Publishing

But, participation in global markets is not just governed by trade policies in final market countries. It also reflects the strategic decision of the lead firms in the value chains. They may have made a strategic decision to locate their activities in a particular country or region, perhaps to balance out the consequences of exchange rate movements or ethnic and nationality ties. For example, before the introduction of the Euro, the major automobile companies tried to effectively balance their purchases of components and final cars in the major European markets, so that if exchange rates moved, then the swings would balance out the roundabouts. Britain's failure to join the Euro is hitting British-based producers precisely for this reason, that is not so much because of high production costs, but because lead-firms shy away from exchange rate instability.

But this phenomenon of connectedness to global markets reflecting the strategic decisions of lead-firms is not confined to Europe. The South African automobile components industry is affected precisely in this manner. Speaking with a broad-brush, the German-owned assemblers – BMW, Mercedes and Volkswagen – have made a strategic decision to use South Africa as a production platform to meet some of their global requirements. This means that the component suppliers feeding into these German owned suppliers have an expanding export market. By contrast, the Japanese, French and US owned assemblers do not treat their South African affiliates in the same way which means that their component suppliers, however efficient, have much less ready access to global markets than do those serving the German-owned assembly plants. An interesting element of this story – widely mirrored in other environments – is the copy-cat policy of different TNCs (often from the same country) in oligopolistic markets. Thus, the decision by Mercedes-Benz to locate in South Africa led both of its German rivals to respond with similar investments.

Value chain analysis has an important role to play here. What it does is to ensure that the analysis treats the whole cycle of production, including that governing connectedness to final markets. This forces the analysis to consider not just the efficiency of the production link in the chain, but also those factors which determine the participation of particular groups of producers in final markets. Gereffi's recent work on what he calls "triangular manufacturing" in the clothing chain is a good example of the use of value chain analysis in this regard. He shows that initially the Hong Kong clothing industry produced directly for the US market. When this avenue was closed (because quotas were filled), these same entrepreneurs changed their functions in the value chain, coordinating the production of these clothes in third countries – initially China and in the region, and then subsequently in other countries such as Mauritius – and passing these clothes to buyers in final markets. More recently, they have begun to brand these products themselves, in some cases by purchasing retail outlets in Europe and North America (such as Pringle golf wear and Tommy Hilfiger) and in other cases by striving to establish their own brand names. Often, ethnic links play an important role, leading key buyers to choose particular producing firms and particular countries from a range of potential options. For example Renault and Peugeot-Citroen have consciously located the largest part of their supply base in surrounding French-speaking regions.

Schmitz's analysis of the leather shoe value chain, focusing on producers in Brazil and China and buyers in the USA shows, too, that particular forms of connectedness will affect the extent to which firms can upgrade. In the Brazilian case, the large-

volume US buyers were quite happy for the firms to deepen their value added in production; indeed they both encouraged and promoted this. However, they were very resistant to these manufacturers developing the capacity to design and market these shoes, which the buyers saw as their source of competitive advantage and their rents in the value chain.

Guide Questions 2

As trade barriers decline, what factors determine access to final product markets?

How important are ethnic links in connecting producers to final markets?

How might the way in which producers connect to final markets affect their capacity to change their mix of activities, or the links which they perform in the value chain?

To what extent does the competitive positioning of TNCs affect the capacity of locally-based producers to enter global markets?

Further reading

- For a discussion of changing trade barriers, particularly in relation to the EU, see:

Stevens, C. and J. Kennan (2001), "Post-Lome WTO-Compatible Trading Arrangements", *Economic Paper No 45*, London: Commonwealth Secretariat.

- The competitive oligopolistic positioning of TNCs is an ongoing process with strong historical roots:

Hymer S (1975), "The Multinational Corporation and the Law of Uneven Development" in H Radice (ed), *International Firms and Modern Imperialism*, London, Penguin.

- An example of how different origins of TNC ownership can affect connectedness to global markets can be seen from the recent experience of South African auto industry

Barnes J. and Kaplinsky R (2000), "Globalisation and the death of the local firm? The automobile components sector in South Africa", *Regional Studies*, Vol. 34, No. 9, 2000, pp. 797-812., 2000

- The role played by ethnicity in global value chain sourcing is described in:

Saxenian, A (1996), *Regional Advantage*, Cambridge, Mass: Harvard University Press.

- The role played by triangular manufacturing in the clothing value chain is described in

Gereffi, G (1999), "International Trade and Industrial Upgrading in the Apparel Commodity Chain", *Journal of International Economics*, Vol. 48, No. 1, pp 37-70.

3.2.1 Making the best of globalisation

The third major reason why value chain analysis is important is that it helps to explain the distribution of benefits, particularly income, to those participating in the global economy. This makes it easier to identify the policies which can be implemented to enable individual producers and countries to increase their share of these gains. This is an especially topical issue at the turn of the millennium and has captured the attention of a wide variety of parties. Invariably the debate is polarised between two

views – globalisation is good for the poor *or* globalisation is harmful for the poor. Yet this is much too simplistic a perspective, since it is less a matter of globalisation being intrinsically good or bad, than *how* producers and countries insert themselves in the global economy. Understanding why this is the case – and how value chain analysis can help both understand these dynamics (positive analysis) and then fashion an appropriate policy response (normative analysis) - requires a detour in the discussion, identifying the dangers arising from a harmful pattern of insertion into the global, economy.

3.2.2 The march of globalisation

Globalisation is defined as the pervasive decline in barriers to the global flow of information, ideas, factors (especially capital and skilled labour), technology and goods. It is thus clear that it has many dimensions. It is also complex, since the barriers to global interchange in the various spheres of human intercourse are changing at a varying pace, and often have regional dimensions (for example, integration within Europe is now occurring at a more rapid pace than integration between Europe and Africa). One important indicator of globalisation – often used to the exclusion of all others – is in regard to international integration through trade. As we can see from Figure 4, the ratio of global exports to global GDP has grown steadily and significantly since the early 19th century, although (and this is an important caveat) the trend dipped sharply downwards in the 1930s, after which it took three decades to reach previous levels.

Box 3: Internationalisation and globalisation

Globalisation can be defined as the pervasive decline in barriers to the global flow of information, ideas, factors (especially capital and skilled labour), technology and goods.

Internationalisation in the late nineteenth century tended to be in commodities or final products. Globalisation in the late twentieth century is increasingly in sub-components and services.

Further reading

□ For a discussion of the evolution of the global economy, and its growing integration, see:

Bairoch Paul and Richard Kozul-Wright (1996), "Globalization Myths: Some Historical Reflections on Integration, Industrialization and Growth in the World Economy", UNCTAD Discussion Papers No 13 March, Geneva.

Dicken P (1998) Global Shift: Transforming the World Economy, Paul Chapman, London.

Maddison, A., (1995), Monitoring the World Economy 1820-1992, Paris: OECD

□ For an analysis of the growing fragmentation of global trade:

Feenstra R. C. (1998), 'Integration of Trade and Disintegration of Production in the Global Economy', Journal of Economic Perspectives, Vol. 12, No. 4, pp.31–50.

Hummels D., Jun Ishii and Kei-Mu Yi (1999), "The Nature and Growth of Vertical Specialization in World Trade", Staff Reports Number 72, New York: Federal Reserve Bank of New York.

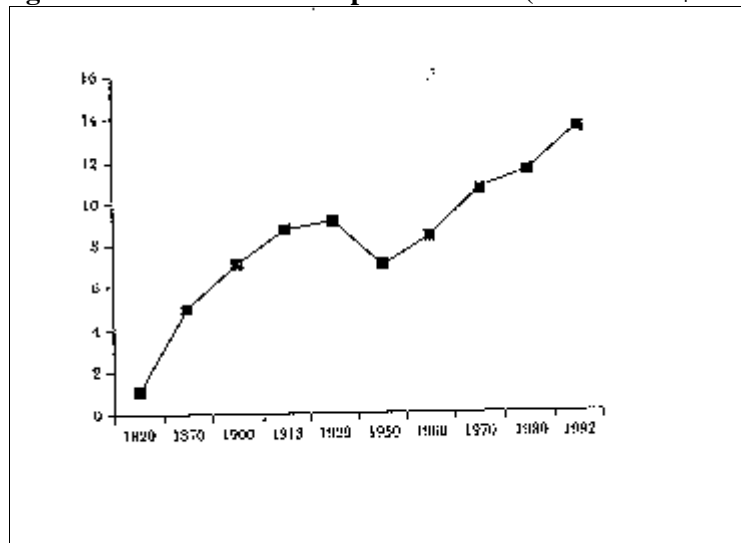
Figure 4. Ratio of World Exports to GDP (in constant \$1990)

Source: Maddison 1995.

The extent of the integration of different economies into global product markets varies, and is affected by a number of factors (most notably the size of the economy). What is especially striking, and of growing significance for developing country exporters as we shall see below, is the growth in export/GDP ratios of low income countries in recent decades, particularly China and India (Table 1).⁶

Table 1: Trade as a proportion of GDP

Imports + Exports as a % of GDP	1960	1970	1985	1995
<u>By income categories:</u>				
High income	23.7	27.1	37.3	39.8
Middle income				55.9
Upper middle income	34.3	36.4	41.8	51.4
Lower middle income				58.7
<u>By region:</u>				
East Asia & Pacific	20.1	18.6	35.7	58.3
Latin America & Caribbean	25.8	23.4	30.8	35.6
Sub-Saharan Africa	47.4	44.3	51.0	56.1
Low income, excl. China & India		34.6	41.8	60.5
China	9.3	5.2	24.0	40.4
India	12.5	8.2	15.0	27.7
World	24.5	27.1	37.1	42.5

Source: World Development Indicators, 1998.

3.2.3 Winners and losers from globalisation

Many have gained from globalisation...

A great many people in the world have gained from growing openness in factor and product markets, in communications, in cultural interchanges and in travel. Many of the world's population have experienced significant improvements in living standards

⁶ These are widely-chronicled events. But see Baldwin and Martin (1999) for a recent review of this evidence and a helpful comparison with levels of integration during the late nineteenth century.

in recent years. By 1998 there were 670m more people living above the “absolute poverty” line than in 1990. (That is, their incomes, measured in 1985 purchasing power parity consumption standards which take account of living costs in different countries exceeded \$1 per day). This represents a major advance in human welfare, and a pace and degree of improvement which is historically unprecedented. East Asia was a major beneficiary, especially after the 1960s, and China and India after 1980. For example, the Chinese economy grew at an annual rate of 10.2 per cent during the 1980s and of 12.8 per cent during the first half of 1990s. Much of the benefits of this growth have filtered through to a large number of people. More than 80m Chinese were pulled out of absolute poverty between 1987 and 1998.

But not everyone has gained...

The forces which continue to propel openness are testament to the extent of these gains and to the economic and political power of its beneficiaries. Yet, at the same time, there have also been a large number of ‘casualties’:

- those who have been excluded from globalisation
- those who have suffered from globalisation
- those who have gained, but remain poor

This is not a ‘north versus south’ phenomenon as some like to characterise it for these groups are to be found in both the industrially advanced and developing economies. The impact of globalisation on inequality is extremely complex. In unravelling this complexity the key challenge is to analytically and empirically distinguish a number of different dimensions that affect the spread of gains from globalisation. These are, namely:⁷

- The numbers living in absolute levels of poverty remained stable, at around 1.2bn between 1987 and 1998
- The inter-country distribution of income has become distinctly more unequal. This is especially true when global income distribution is measured in terms of numbers of people (which takes account of worsening domestic inequality) rather than average inter-country per capita incomes. Inter-country income distribution has also exhibited a “twin peak” pattern, with some countries catching up with the USA, and others falling further behind.
- The intra-country distribution of income worsened in much of the world. The major exceptions to this trend lie in Western Europe. There, government transfers have tended to compensate for growing income inequality so that consumption inequality has not grown as markedly.
- Inequality between skilled and unskilled labour grew in many parts of the world, although in some of the rich countries the rate of unequalisation slowed down during the second half of the 1990s.

⁷ For more details on the spread of inequality, and its complexity, see www.ids.ac.uk/global.

Guide Questions 3

- Who have been the main beneficiaries of globalisation in the late twentieth century?
- Who have been the main losers of globalisation in the late twentieth century?
- If two components of poverty are distinguished – relative and absolute standards of living – how does this change our judgement on the extent of gainers and losers from globalisation?

Further reading

- For data on the spread of gains from globalisation, see:

Förster, M. and M. Pearson (2000), “Income Distribution in OECD Countries”, Paper Prepared for OECD Development Centre Workshop on Poverty and Income Inequality in Developing Countries: A Policy Dialogue on the Effects of Globalisation, Paris

UNDP (2000), Human development Report, N. York, United Nations

Wade, R. (2001), “Is globalisation making world income distribution more equal?”, LSE DSI Working Paper Series, No. 01-01. London: LSE Development Studies Institute.

www.ids.ac.uk/global

World Bank - www.worldbank.org/html/extdr/pb/globalization/papers1

3.2.4 Making the best of globalisation

These various developments pose serious problems for economic management, not just within governments, but also within firms and other institutions. The issue is both one of carrot, and stick. The “carrot” is how to take advantage of the gains which arise from the reduction in global barriers which have allowed many individual firms and countries to specialise, to grow and to profit from globalisation. The “stick” is the pressure coming from multilateral agencies (such as the WTO, the IMF and the World Bank) and most bilateral aid donors (individual country governments) which are forcing recalcitrant countries to insert themselves more deeply into the global economy.

Thus, the key policy issue is not whether to participate in global markets, but how to do so in a way which provides for sustainable income growth. This, as we have seen is a particular problem for poor producers and poor countries who seem to have experienced more of the downside than the upside of globalisation over the past two decades.

3.2.5 Making the worst of globalisation

How can it be that producers deepen their participation in global markets, but land up by being worse off than before they started? The problem which firms, sectors and countries confront is that if they continue to specialise in highly competitive markets,

then they will be increasingly subject to the erosion of their returns due to falling terms of trade. This is a spectre which has long confronted the producers of commodities and agriculture products, but it is increasingly also to be found in the export of manufactures.

Individual firms can get it wrong. Consider, for example, the case of a firm “manufacturing” denim jeans in an export processing zone in the Dominican Republic during the early 1990s (Table 2). It saw its core competence as lying in the sewing of materials imported from the US, designed in the US and cut in the US, and then selling under the brand name of a major international company. Even the logistics of this operation were controlled by the US principle. The local firm, working under contract, began by getting \$2.18 per jean sewn. Then as neighbouring countries devalued (reducing the cost of their labour in US\$), so the Dominican Republic firm was forced to systematically reduce its charge-rate; but even this was not enough and the work was eventually sourced elsewhere. The vulnerability of this firm, therefore, was that it specialised in a narrow function (sewing) within a particular link (production) in the value chain. Its value added was too low to allow for enhanced efficiency and most of the value anyway was appropriated in the design and branding links in this chain.

Table 2: Declining unit prices and investment instability: the case of jeans manufacturing in the Dominican Republic

	Volume (per week)	Unit price (\$)
January 1990	9,000	2.18
October 1990	5,000	2.05
December 1990	3,000	1.87
February 1991	Arrangement terminated and assembly transferred to Honduras	
Total investment in equipment by Dominican Republic firm was US\$150,000		

Source: Kaplinsky (1993).

It is not just firms which can insert themselves inappropriately into global value chains. It can also apply to whole sectors and regions. Consider for example the experience of the South African furniture industry (Box 4) or a clustered group of leather shoe manufacturers in the Sinos Valley in Brazil. Over a two-decade period, these shoe producers built themselves into a major supplier of women’s shoes, particularly to the US, accounting for about 12% of total global exports. Initially sales and exports grew rapidly during the 1970s, and although real wages did not grow significantly, they certainly did not fall. The “connectedness” into the US market was provided by a limited number of large-scale buyers who supplied very large US chain-stores. But once these buyers had established reliable, quality suppliers in Brazil, they then moved their supply-chain management capabilities to China, building competitive capabilities and undercutting the very Brazilian producers which they had helped to upgrade during the 1970s! The consequence was a 40 percent fall in wages in the Sinos Valley’s shoe sector during the 1980s. Here, the problem confronted by the shoe producing sector and region as a whole was very similar to that experienced by the single Dominican Republic firm, notably that they had specialised in those particular links in the value chain (leather and shoe production) which were subject to intense competition. The design and branding links remained in the US.

Box 4: Falling global prices in the wooden furniture sector are extremely dangerous when producers are unable to upgrade

Growing competition in the wooden furniture sector is having a major impact on the wooden furniture industry. At an aggregate level, global prices are falling, as can be seen in the case of EU imports during the 1990s.

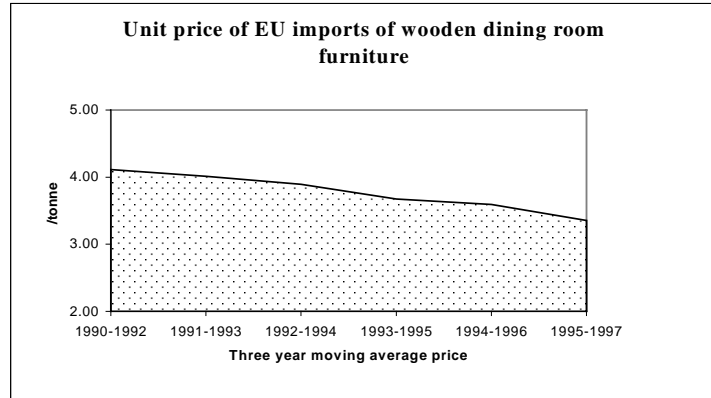

For some developing country producers who are locked into the commodity segments of this market (pine dining room furniture), the fall in prices can be very significant. For example, the Sterling prices of bunk beds and kitchen furniture received by two South African exporters of kitchen doors fell significantly, by more than 20% in four years. As can be seen, the only factor saving this manufacturer of doors was the falling exchange rate, which devalued by more than the rate of inflation in this sector. Although this may have saved the wooden furniture manufacturer, the upshot of devaluation for the economy as a whole is a fall in the international purchasing power of domestic value added.

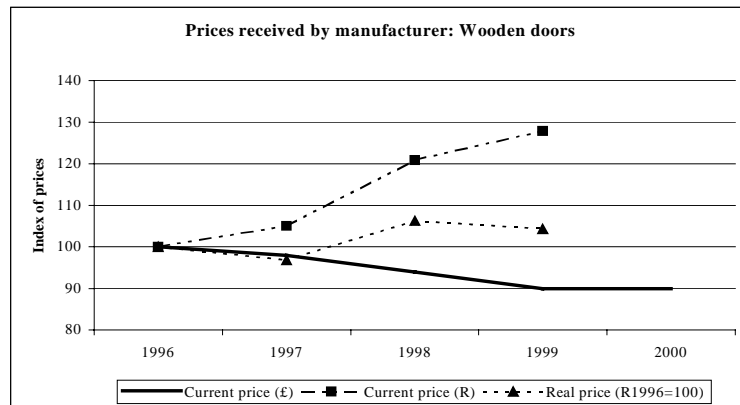

But the impact is not limited to individual manufacturers. The South African furniture industry as a whole saw expanding export volumes and rising export values in local currency. But unit prices fell (from more than \$16/tonne in 1991 to \$6/tonne in 1999) and when converted into US\$, the international purchasing power of these expanding exports actually fell.

South African furniture exports: 1988 to 1999

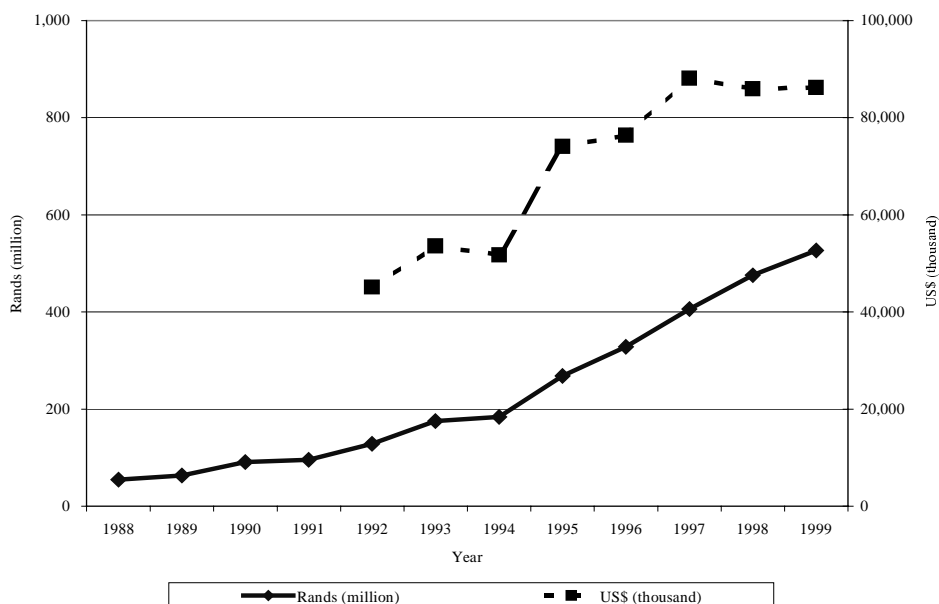

Finally, whole groups of countries can also insert themselves inappropriately into global markets. Historically, countries specialising in primary commodities (minerals and agriculture) have seen their terms of trade decline against manufacturers, and this has been one of the primary reasons underlying the drive towards industrialisation. However, as can be seen from Figure 5, and particularly since China's entry into global markets in the mid-1980s, we have begun to witness a historically significant decline in the terms of trade of developing countries' manufactured exports. So, even manufacturing is no longer a protected domain – countries specialising in labour-intensive manufactured exports are equally vulnerable to misplaced insertion into global markets.

Figure 5: Price of LDC manufactured exports relative to IAC manufactured exports of machinery, transport equipment and services



Source: Wood 1997.

The consequence of the failure of individual firms, groups of firms and national economies to insert themselves appropriately into global markets is that the spectre is raised of '*immiserising growth*' (Box 5). This describes a situation where there is increasing economic activity (more output and more employment) but falling economic returns.

Box 5: Immiserising growth

Immiserising growth is defined as an outcome when overall economic activity increases, but the returns to this economic activity fall. For example:

- if export prices fall faster than export volumes increase, the firm and or the country may be worse off even though economic activity is increased. This has happened to five countries exporting wooden furniture to the EU in the decade 1987-1996
- increased exports can only be paid for by lower wages; in Brazil's shoe exporting sector, between 1970 and 1980 average real wages were stagnant, and during the 1990s they fell by approximately 40 per cent in real terms

Further reading

Kaplinsky, R. and J. Readman (2000), "Globalisation and Upgrading: What can (and cannot) be Learnt from International Trade Statistics in the Wood Furniture Sector?", *mimeo*, Brighton, Centre for Research in Innovation Management, University of Brighton and Institute of Development Studies, University of Sussex

Schmitz, Hubert (1995), "Small Shoemakers and Fordist Giants: Tales of a Supercluster", *World Development*, Vol. 23 No. 1, pp. 9-28.

3.2.6 How does value chain research inform this debate on globalisation?

The key issue thus is *how* producers – whether firms, regions or countries – participate in the global economy rather than whether they should do so. If they get it wrong, they are likely to enter a “race to the bottom”, that is a path of immiserising growth in which they are locked into ever-greater competition and reducing incomes.

Value chain analysis provides a key entry point into this analysis, as well as into the policy implications which are raised:

- It addresses the nature and determinants of competitiveness, and makes a particular contribution in raising the sights from the individual firm to the group of interconnected firms
- By focusing on all links in the chain (not just on production) and on all activities in each link (for example, the physical transformation of materials in the production link), it helps to identify which activities are subject to increasing returns, and which are subject to declining returns.
- As a result of being able to make these distinctions regarding the nature of returns throughout the various links in the chain, policy makers are hence assisted in formulating appropriate policies and making necessary choices. These may be to protect particularly threatened links (e.g. poor informal operators) and/or facilitate upgrading of other links in order to generate greater returns.

- It shows that even though competitiveness may have been achieved, the mode of connectedness into the global economy may require a focus on macro policies and institutional linkages, and these require a different set of policy responses to those which deliver firm-level competitiveness
- Participating in global markets, however competitive at a single point in time, may not provide for sustained income growth over time. By focusing on the trajectory which participation in global markets involves, value chain analysis allows for an understanding of the dynamic determinants of income distribution.
- Value chain analysis need not be confined to assessing the extent to which participation in global markets determines the spreading of the gains from globalisation. It can also be used to understand the dynamics of intra-country income distribution, particularly in large economies.

Guide Questions 4

- Does participation in global markets guarantee a sustained increase in living standards?
- If it does not, in what ways can producers participate in global markets successfully and then be worse off than they were before?
- If some firms do not participate effectively in global markets, does this mean that the sector or the country as a whole is necessarily worse off?
- In what way can immiserising growth be gauged from data on export volume growth, export value growth and unit prices?
- How does value chain analysis help to explain the ways in which individual firms, or linked groups of firms, can participate more effectively in global markets?
- Is production efficiency – even that involving close cooperation between firms in the value chain – adequate to sustain income growth in a global economy?

PART 2: KEY ANALYTICAL CONSTRUCTS

In this Part 2 of the Handbook we define and discuss some of the key analytical constructs which inform value chain analysis focussing on the manner and trajectory in which producers enter and then participate in wider markets. These wider markets may be different regions of a particular national economy, an economic region or the global economy. This is in tune with our earlier definition of globalisation as involving the pervasive decline in barriers to the flow of information, ideas, factors (especially capital and skilled labour), technology and goods.

In this Part we address four major analytical issues:

- We begin by discussing the difference between a value chain perspective which is heuristic (that is, allowing for a better description of the world) and one which is more analytical (that is, explaining *why* the world takes the form it does)
- We then consider the question of upgrading. As we shall see, participating in global markets which allows for sustained income growth requires the capacity to learn and upgrade.
- From this, value chain analysis can be used to help to understand the determinants of income distribution.
- We conclude by briefly describing how value chain research differs from and compliments other forms of social and economic analysis.

This sets the scene for Part 3 in which we set out a methodology for conducting value chain research.

4 IS THE VALUE CHAIN A HEURISTIC DEVICE OR AN ANALYTICAL TOOL?

At the simplest level, as reflected in Figures 1-3, value chain analysis plots the flow of goods and services up and down the chain, and between different chains. This is in itself a valuable task

Considered in this way, the value chain is a descriptive construct, at most providing a heuristic framework for the generation of data. However, recent developments in value chain theorisation have begun to provide an analytical structure which, as we shall see below, provides important insights into our twin concerns with the determinants of global income distribution and the identification of effective policy levers to ameliorate trends towards unequalisation.⁸ There are three important components of value chains which need to be recognised and which transform an heuristic device into an analytical tool:

- Value chains are repositories for rent, and these rents are dynamic
- Effectively functioning value chains involve some degree of ‘governance’
- There are different types of value chains

4.1 Three key elements of value chain analysis

4.1.1 Barriers to entry and rent⁹

The value chain is an important construct for understanding the distribution of returns arising from design, production, marketing, coordination and recycling. Essentially, the primary returns accrue to those parties who are able to protect themselves from competition. This ability to insulate activities can be encapsulated by the concept of *rent*, which arises from the possession of scarce attributes and involves *barriers to entry*.

There are a variety of forms of rent. The focus of much of the literature, entrepreneurial energies and government policies is on what is called economic rents. The classical economists (such as Ricardo) argued that economic rent accrues on the

⁸ Unfortunately, the phrase ‘value chain’ covers both the heuristic and analytical categories. This has led some to search for a different nomenclature. For example, Gereffi has coined the phrase ‘global commodity chain (GCC)’ (Gereffi, 1994), and in a recent contribution argues that the GCC is distinct in that it incorporates an international dimension, that it focuses on power of lead firms and the coordination of global activities, and that it explicitly recognises the importance of organisational learning (Gereffi, 1999b). These are proximate to the three characteristics which we address in this paper. But, although representing a major contribution to our thinking on global production networks, Gereffi’s *phrase* ‘global commodity chain’ suffers because the word ‘commodity’ implies the production of undifferentiated products in processes with low barriers to entry. The problem with this, as we shall see below, is that the search for sustainable income growth requires producers to position themselves precisely in non-commodity, high barriers to entry activities in the value chain. For these reasons, and in the absence of an agreed phraseology, we will continue to use the words ‘value chain’, but to do so in an analytical context.

⁹ For a longer discussion of economic rent see Kaplinsky (1998) and Kaplinsky (2002 forthcoming).

basis of unequal ownership/access or control over an existing scarce resource (eg. land). However as Schumpeter showed, scarcity can be constructed through purposive action, and hence an entrepreneurial surplus can accrue to those who create this scarcity. For Schumpeter this is essentially what happens when entrepreneurs innovate, creating ‘new combinations’ or conditions, which provide greater returns from the price of a product than are required to meet the cost of the innovation. These returns to innovation are a form of super profit and act as an inducement to replication by other entrepreneurs also seeking to acquire a part of this profit.

Figure 6 shows the process at work. In each industry the equilibrium is defined by the ‘average’ rate of profit. Following the introduction of a ‘new combination’ the entrepreneur reaps a ‘surplus’ – what we might term a producer rent. Then as this is copied – a process of diffusion – the producer rent is whittled away, prices fall, and the innovation accrues in the form of consumer surplus. But all this does is to renew the search for a ‘new combination’, either by the same entrepreneur or another entrepreneur, in the continual search for entrepreneurial surplus.

Figure 6: The generation and dissipation of entrepreneurial surplus

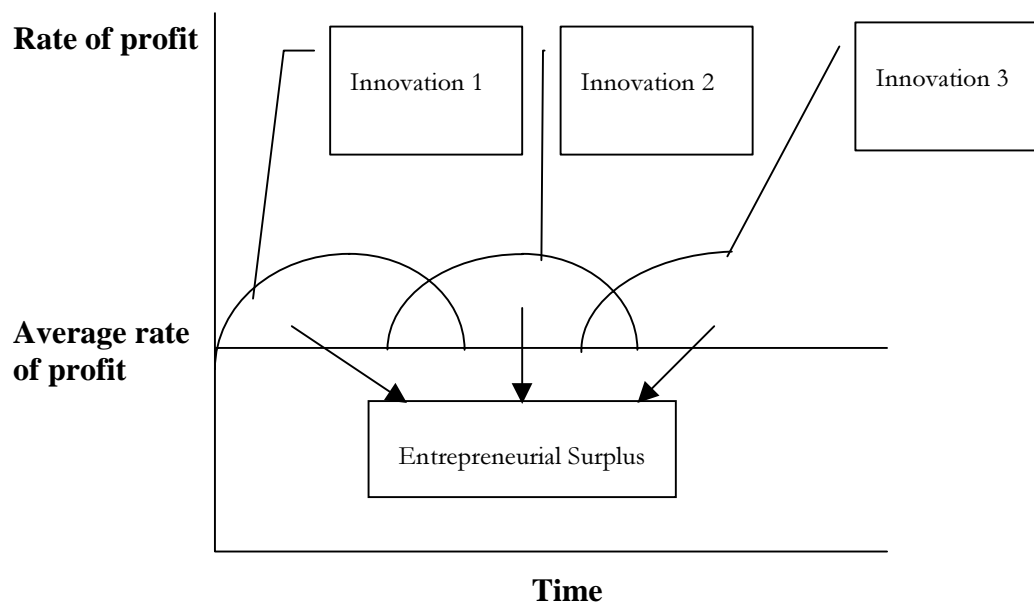

In summary, economic rent

- arises in the case of differential productivity of factors (including entrepreneurship) *and* barriers to entry (that is, scarcity)
- takes various forms within the firm, including technological capabilities, organisational capabilities, skills and marketing capabilities (such as brand names). (These cluster of attributes are often discussed in relation to dynamic capabilities and core competences in the literature).
- but they may also arise from purposeful activities taking place between groups of firms – these are referred to as relational rents.

- have become increasingly important since the rise of technological intensity in the mid-nineteenth century (Freeman, 1976) and the growth of differentiated products after the 1970s (Piore and Sabel, 1984).
- is dynamic in nature, eroded by the forces of competition after which it is then transferred into consumer surplus in the form of lower prices and/or higher quality

The process of competition – the search for ‘new combinations’ to allow entrepreneurs to escape the tyranny of the normal rate of profit, and the subsequent bidding away of this economic rent by competitors – fuels the innovation process which drives capitalism forward.

As more and more countries have developed their capabilities in industrial activities, so barriers to entry in production have fallen and the competitive pressures have heightened (Figure 7). This has become particularly apparent since China, with its abundant supplies of educated labour, entered the world market in the mid-1980s.¹⁰ It is this, too, which underlies the falling terms of trade in manufactures of developing countries (see Figure 5 in Part 1 above).

Consequently, it is sometimes argued that the primary economic rents in the chain of production are increasingly to be found in areas outside of production, such as design, branding and marketing. Yet, as we shall see, this is too simple a conclusion, since even within production some activities involve greater barriers to entry. The pervasive trend, as we shall see is towards control over disembodied activities in the value chain.

Figure 7. Competitive Pressures in the Value Chain

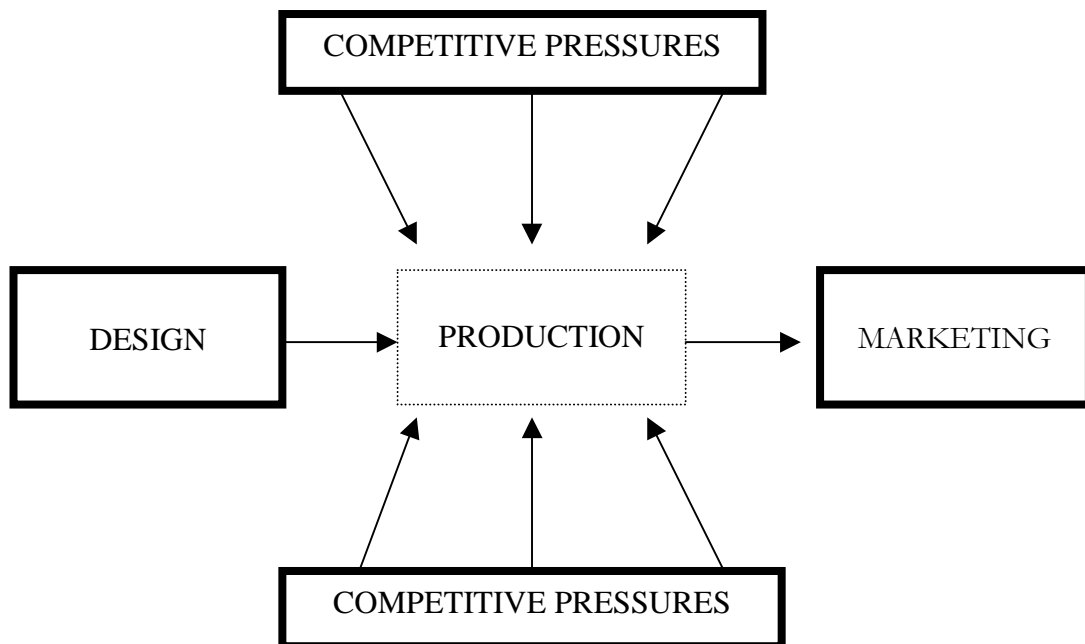

¹⁰ The share of manufactures in total exports rose from 49.4 in 1985 to 85.6 per cent in 1995 (Khan, 1999).

But not all rents are producer rents (Box 6). Some arise from the command over scarce natural resources (such as access to deposits of diamonds), and others are provided by parties external to the chain. For example, efficient government policy makes it easier for the firm to construct economic rents through providing better access to human skills, and better infrastructure and more efficient financial intermediation than in competitor countries. Governments may also protect producers from competition, not just through firm-specific policies such as import-controls, but also through factor-specific policies such as controls on immigration. (We will return to this issue in the discussion of income distribution below).

Box 6: Different Forms of Economic Rent

1. Economic rent arises in the case of differential productivity of factors *and* barriers to entry
2. There are a variety of forms of economic rent prevalent in the global economy; Some are endogenous and are “constructed” by the firm and are classical Schumpeterian rents:
 - ❑ Technology rents – having command over scarce technologies
 - ❑ Human resource rents – having access to better skills than competitors
 - ❑ Organisational rents – possessing superior forms of internal organisation
 - ❑ Marketing rents – possessing better marketing capabilities and/or valuable brand names

Other rents are endogenous to the chain, and are constructed by groups of firms:

 - ❑ Relational rents – having superior quality relationships with suppliers and customers
3. But rents can also be exogenous to the chain and arise through the bounty of nature:
 - ❑ Resource rents – access to scarce natural resources
4. Producers can also gain from the rents provided by parties external to the chain:
 - ❑ Policy rents – operating in an environment of efficient government; constructing barriers to the entry of competitors
 - ❑ Infrastructural rents – access to high quality infrastructural inputs such as telecommunications
 - ❑ Financial rents – access to finance on better terms than competitors
5. Rents are dynamic – new rents will be added over time, and existing areas of rent will be eroded through the forces of competition

4.1.2 Governance

A second consideration which helps to transform the value chain from an heuristic to an analytical concept is that the various activities in the chain – within firms and in the division of labour between firms – are subject to what Gereffi has usefully termed ‘governance’ (Gereffi, 1994). Value chains imply repetitiveness of linkage interactions. Governance ensures that interactions between firms along a value chain exhibit some reflection of organisation rather than being simply random. Value chains are governed when parameters requiring product, process, and logistic qualification are set which have consequences up or down the value chain encompassing bundles of activities, actors, roles, and functions.

This is not necessarily the same thing as the co-ordination of activities by various actors within a value chain. Value chains are coordinated at different places in the linkages in order to ensure these consequences (intra firm, inter firm, regional) are managed in particular ways. Power asymmetry is thus central to value chain governance. That is, there are key actors in the chain who take responsibility for the inter-firm division of labour, and for the capacities of particular participants to upgrade their activities. As we saw in Part 1, this is important because the intricacy and complexity of trade in the globalisation era requires sophisticated forms of coordination, not merely with respect to positioning (who is allocated what role in the value chain) and logistics (when and where intermediate inputs, including services, are shipped along the chain), but also in relation to the integration of components into the design of the final products, and the quality standards with which this integration is achieved. Coordination usually involves managing these parameters as they are exhibited in bundles of activities undertaken by various actors performing specific roles in the chain. It also requires monitoring of the outcomes, linking the discrete activities between different actors, establishing and managing the relationships between the various actors comprising the links, and organising the logistics to maintain networks of a national, regional or global nature. It is this role of coordination, and the complementary role of identifying dynamic rent opportunities and apportioning roles to key players which reflects an important part of the act of governance.

However, coordination does not require that a single firm engages in these roles. Indeed there may well be a multiplicity of nodal points of governance and coordination functions. Furthermore these nodal points may change over time as the prominence accorded to different firms/actors shifts within a value chain. This issue is often confused by using the terms ‘drivers’ or ‘lead firms’ as encompassing the different roles of governance, management and coordination, as well as being regarded as synonymous with either a concrete actor(s) role in coordinating/exercising power or a statement of the characteristics of governance defining the value chain. For example, is a particular value chain ‘buyer-driven’ because a lead firm controls branding/marketing and hence ensures consequences along the value chain? Or is it because this lead firm plays the driver role (i.e. a coordination and management function) within the value chain?

This also causes confusion in regard to the issue of exercising power in a value chain. Power can be exercised in various forms. Within a value chain this can be understood in at least two separate forms – a) ensuring consequences along the chain, and b) actively managing or coordinating the operations of the links within the chain to

ensure that these consequences are met. For example, the emergence of full package providers does not mean that this particular value chain is no longer ‘buyer driven’. It simply means that the coordination/management role has been concentrated elsewhere in the chain. If the full package provider can incorporate own-branding then this might well constitute a major shift in governance functions. Likewise, in the auto industry, the emergence of modular assembly under the control of multinational first tier suppliers within a ‘producer driven chain’ simply means that the coordination/management function has been driven down the chain. The governance function which defines the basic operations of the chain is still concentrated within the vehicle assemblers.

In trying to understand the role of governance in global value chains we can be informed by the discussion of governance in civil society. Here four elements are relevant:

- There is an important distinction between the three functions of government (the “separation of powers”) - the legislature (making the laws), the executive (implementing the laws) and the judiciary (monitoring the conformance to laws)
- To be effective, the power to govern requires the capacity to sanction behaviour; these sanctions are generally negative and are directed against transgressions (the “stick”), but they may also be positive and may reward conformance (the “carrot”)
- In the long run, sustained governance reflects the legitimacy of those in power.
- The remit of power may vary in intensity and in physical and economic space.

How does this backdrop of political analysis affect our understanding of the role of governance in global value chains?

Beginning with the classical separation of powers, it is possible to *distinguish three forms of value chain governance*. First, the basic rules which define the conditions for participation in the chain need to be set. In the past, these rules were largely concerned with meeting basic cost parameters and guaranteeing supply, but increasingly as Japanese management practices spread during the 1990s, the critical success factors came to include what is known as “QPD” (that is quality, price and delivery reliability). More recently, the “rules” of participation have increasingly come to include conformance to international standards such as ISO9000 (on quality), ISO14000 (on environment), SA8000 (labour standards) and other industry-specific standards such as phyto-sanitary and HACCP (hazard analysis and critical control point) in the food processing industry. The definition of these various sets of rules as defining the basis of participation in value chains can be termed ‘*legislative governance*’, i.e. setting the parameters governing the value chain.

But it is also necessary to audit performance and to check compliance with these rules – this can be seen as ‘*judicial governance*’, i.e. coordinating the conformance to the set parameters. However in order to meet these rules of participation, there needs to be some form of proactive governance (which might be termed ‘*executive governance*’) which provides assistance to value chain participants in meeting these operating rules, i.e. managing the various subordinate links in the value chain. This

executive governance may be direct (helping a supplier achieve quality standards for example) or indirect (forcing a first-tier supplier to assist a second-tier supplier, or introducing a supplier to a service sector firm which can assist it in meeting the standards which are required). As Figure 8 shows, these governance roles may be provided by producers in the chain (that is, from within) or by parties external to the chain (that is, from without).

Much of the existing discussion of governance fails to recognise this threefold distinction, partly because in some cases the same party is believed to covers all three sets of powers. For example, it is sometimes (incorrectly) asserted that in the auto industry, Toyota defines the rules which it requires its suppliers to achieve, audits their performance and actively itself helps its suppliers to achieve these ends (which it does not in fact generally do, relying on its suppliers to work with its sub-suppliers). Together these activities are bundled together under the banner of “supply-chain management/learning”. But, in reality it is seldom the case that the three functions are in fact performed by the same firm, which is one of the reasons why the supply chain literature has difficulty in explaining the prevalence of value chain inefficiency in the real world.

Figure 8: Examples of legislative, judicial and executive value chain governance

	Exercised by parties internal to chain	Exercised by parties external to chain
Legislative governance	Setting standards for suppliers in relation to on-time deliveries, frequency of deliveries and quality	Environmental standards Child labour standards
Judicial governance	Monitoring the performance of suppliers in meeting these standards	Monitoring of labour standards by NGOs Specialised firms monitoring conformance to ISO standards
Executive governance	Supply chain management assisting suppliers to meet these standards Producer associations assisting members to meet these standards	Specialised service providers Government industrial policy support

The exercising of *sanctions* is key to the function of governance in value chains. The ultimate negative sanction is whether a particular party is included or excluded in the production network, and has access to final markets. But there may be intermediate forms of negative sanctions as well, such as limiting the role which particular producers play in the chain, or imposing cost penalties for non-conformance. Not all sanctions are negative, of course, and there may be various forms of reward which governors may mete out. For example, the ability to meet specified quality standards on a regular and sustained basis may mean that a supplier will not be subject to the same level of auditing as previously.

The third element of civic governance is *legitimacy*. In democratic societies – however constituted – the right to sanction behaviour reflects popular support. By contrast, one of the defining characteristics of non-democratic systems is that the command of force (negative sanctions) lies in the hands of those without popular

legitimacy. The closest correspondence to this in value chain governance lies in the degree of trust between different parties, and particularly of the “governor”. Crudely speaking, a distinction can be made between arms-length relationships and obligation relationships (Sako, 1992; Humphrey et al, 1998). In the former low-trust chain, suppliers are frequently changed to pursue short-term price advantages and failure to conform with the wishes of the governor leads to the rapid sanction of exclusion from the chain. These low trust relationships characterised the era of mass production. By contrast in modern flexible production systems (sometimes referred to as the era of “mass customisation”), trust becomes increasingly important, and failure to reach the required level of standards does not automatically result in the sanction of exclusion; instead executive governance is exercised to assist the transgressing party to achieve the required levels of performance. High-trust relationships, in which the governor has legitimacy from other links in the chain tend to be associated with long-lived relationships – Toyota and its suppliers is a case in point. Low-trust relationships with low levels of legitimacy have a high rate of “churn” amongst suppliers.

The final characteristic of governance concerns its depth and pervasiveness, that is its “richness” and “reach” (Evans and Wurster, 2000). By depth we refer to the extent to which it affects the core activities of individual parties in the chain. For example, do the rules which are set by the value chain governors affect the core or peripheral operations of individual links in the value chain? But we also need to know how widely over the chain its power is exercised, and related to this, whether there are competing bases of power. The simplicity of the value-chain-governance concept is belied very often by the complexity of real-world relations and many value chains are characterised by a multiplicity of “governors”, often laying down conflicting rules to the poor producers who serve their needs.

4.1.3 Different types of value chains

Building on this concept of governance, Gereffi has made the very useful distinction between two types of value chains (Box 7). The first describes those chains where the critical governing role is played by a buyer at the apex of the chain. *Buyer-driven chains* are characteristic of labour intensive industries (and therefore highly relevant to developing countries) such as footwear, clothing, furniture and toys. The second describes a world where key producers in the chain, generally commanding vital technologies, play the role of coordinating the various links – *producer-driven chains*. Here producers take responsibility for assisting the efficiency of both their suppliers and their customers. In more recent work, Gereffi has pointed out that producer-driven chains are more likely to be characterised by foreign direct investment (FDI) than are buyer-driven chains (Gereffi, 1999b). He also argues that each of these different types of value chain is associated with different types of production systems (Figure 9). More contentious is the suggestion that producer driven chains are a reflection of the old “import substituting industrialisation order”, whereas buyer-driven chains are more attuned to the outward-oriented and networked production systems of the 21st century.

Box 7: Buyer and producer driven value chains

“Producer-driven commodity chains are those in which large, usually transnational, manufacturers play the central roles in coordinating production networks (including their backward and forward linkages). This is characteristic of capital- and technology-intensive industries such as automobiles, aircraft, computers, semiconductors, and heavy machinery.”

“Buyer-driven commodity chains refer to those industries in which large retailers, marketers, and branded manufacturers play the pivotal roles in setting up decentralized production networks in a variety of exporting countries, typically located in the third world. This pattern of trade-led industrialization has become common in labor-intensive, consumer goods industries such as garments, footwear, toys, housewares, consumer electronics, and a variety of handicrafts. Production is generally carried out by tiered networks of third world contractors that make finished goods for foreign buyers. The specifications are supplied by the large retailers or marketers that order the goods.”

Source: Gereffi, 1999b

This distinction between different types of value chains is at this stage of the research process still something of a research hypothesis, as is the suggestion that we are seeing a shift from a producer-driven to a buyer-driven world. Three caveats must be entered:

- Some value chains exhibit very little governance at all, or at best very thin forms of governance
- In most value chains there are multiple points of governance (in all three areas of legislative, judicial and executive governance). At any one point in time, a number of different parties may be setting rules (which may differ in nature), auditing performance and assisting producers to achieve the required standards. These parties may be from within the chains themselves or in the local community or in business associations. There may thus be overlaps between vertical and horizontal forms of governance.¹¹
- Some chains may embody both producer- and buyer-driven governance. For example, in clothing, the GAP is an excellent example of a firm without its own manufacturing facilities and represents a classic form of buyer-drivenness, whereas Levi-Strauss governs a vertically integrated value chain. In autos there are signs that Ford is making the transition to buyer-driven chains whereas Toyota and other producers continue to command producer-driven chains. In semiconductors INTEL commands a producer-driven chain, whereas ARM uses silicon foundries to satisfy its customer base.

¹¹ This overlap is the subject of ongoing research at the Institute of Development Studies in Sussex in a collaborative research programme with partners in Brazil, Germany and Pakistan.

Figure 9: Producer- and buyer-driven chains compared

	Producer-Driven Commodity Chains	Buyer-Driven Commodity Chains
Drivers of Global Commodity Chains	Industrial Capital	Commercial Capital
Core Competencies	Research & Development; Production	Design; Marketing
Barriers to Entry	Economies of Scale	Economies of Scope
Economic Sectors	Consumer Durables Intermediate Goods Capital Goods	Consumer Non-durables
Typical Industries	Automobiles; Computers; Aircraft	Apparel; Footwear; Toys
Ownership of Manufacturing Firms	Transnational Firms	Local Firms, predominantly in developing countries
Main Network Links	Investment-based	Trade-based
Predominant Network Structure	Vertical	Horizontal

Source: Gereffi, 1999b

So, although the buyer- versus producer-driven value chain distinction is a useful one in framing a series of research questions, it should perhaps be seen as a null hypothesis to be tested rather than a proven research conclusion. But, if this binary distinction does not prove to be robust, are there alternative approaches which help us understand the evolving nature of governance? One alternative perspective reads as follows:

- The key shift we are witnessing in an increasingly globalised and competitive world is a transition from rents accruing from tangible activities to those arising from intangible activities in the value chain
- This is because intangible activities are increasingly knowledge- and skill-based and are imbedded in organisational systems;¹² the knowledge they incorporate is

¹² It is important to recognise that the concept of “skill” embodies the idea of rent. When we talk about “skill”, we refer to aptitudes and knowledge which are not widely available. This is both inherently relative, and dynamic. For example, two decades ago, primary and secondary education were relatively skilled attributes in a labour-force; now they are very common.

thus tacit in nature, and this involves growing barriers to entry. By contrast, the capabilities in the tangible realm are increasingly widespread, particularly following the entry of China into the global economy.

- The intangibles are to be found in all links – for example, the control of logistics in the production phase, the conceptual phase in advertising. But certain links in the value chain are particularly rich in intangible activities, such as design and branding, and the coordination of the chain itself
- The shift from producer- to buyer-driven chains is therefore illusory and arises because at this point in the competitive cycle, branding and marketing are becoming increasingly important in many chains. However, a closer examination of chains will however show a pervasive shift to a wider arena of intangibles and it is because of this that a chain can simultaneously appear to be both buyer- and producer-driven
- Similarly particular product families (for example, toys or clothing) may simultaneously have buyer-driven and producer-driven chains, depending on which intangibles the lead parties dominate.

In the discussion of methodology in Part 3 below we will return to this distinction between different types of value chains.

Even at the other end of the training spectrum, masters postgraduate degrees are increasingly common and even doctorates are losing their scarcity value.

Guide Questions 5

- Why does the existence of skilled labour and good infrastructure in themselves not provide a source of high incomes? When do these endowments provide rents?
- Give examples of barriers to entry which are socially-constructed and those which are natural?
- What is the role of intellectual property rights in creating and sustaining barriers to entry?
- How pervasive is governance in different global value chains?
- Why is it important to make the distinction between legislative, executive and judicial governance in global value chains?
- What sanctions are available to value chain governors, and how effective might these be in determining behaviour of different chain participants?
- Are different value chains *either* buyer- *or* producer-driven, or can these different forms exist in the same value chain?
- Is there an inexorable drift from producer-driven to buyer-driven value chains?
- What role will e-business have on governance in global value chains?

Further reading

On *governance*, see:

Various papers in Gereffi, G. and R. Kaplinsky (eds.), "The Value of Value Chains", IDS Bulletin, Vol. 32, no 3, 2001.

Gereffi, G. (1994), "The Organization of Buyer-Driven Global Commodity Chains: How U. S. Retailers Shape Overseas Production Networks", in G. Gereffi and M. Korzeniewicz (eds.), Commodity Chains and Global Capitalism, London: Praeger.

Gereffi, G (1999), "International Trade and Industrial Upgrading in the Apparel Commodity Chain", Journal of International Economics, Vol. 48, No. 1, pp 37-70.

On *economic rent*, see:

Kaplinsky, R. (2002, forthcoming), "Gaining From Global Value Chains: The Search for the Nth Rent", in G. Gereffi (ed.), Who Gets Ahead in the Global Economy? Industrial Upgrading, Theory and Practice, New York: Johns Hopkins Press.

5 VALUE CHAINS, INNOVATION AND UPGRADING

In Part 1 we distinguished two paths of insertion into the global economy. The low road was one of immiserating growth, a trajectory in which producers faced intense competition and were engaged in a “race to the bottom”. By contrast, those who had trod a high road, and exhibited the ability to enter a virtuous circle of participation in the global economy, realising sustained income growth. What explains the difference between these two paths? A key capability is the capacity to *innovate*, and to ensure continuous improvement in product and process development. If this is the case, then the emphasis in production therefore needs to be placed on the ability to learn and this has implications not just for the productive sector itself, but also for the whole National System of Innovation (Lundvall, 1992; Nelson and Winter, 1993).

But innovation in itself may not be adequate. If the rate of innovation is lower than that of competitors, this may result in declining value added and market shares; in the extreme case it may also involve immiserating growth. Thus innovation has to be placed in a relative context – how fast compared to competitors - and this is a process, which can be referred to as one of *upgrading*. The concept of upgrading (as distinct from innovation) explicitly recognises relative endowments, and hence the existence of rent.

Different types of upgrading

But how would we know if firms had managed to upgrade their activities? Two schools of thought have addressed this issue in recent years. The first has been that focusing on core competences (Hamel and Prahalad, 1994). The thinking here is that firms need to examine their capabilities to determine those of its attributes which:

- provide value to the final customer
- are relatively unique in the sense that few competitors possess them
- are difficult to copy, that is where there are barriers to entry.

The capacity to innovate therefore arises from concentration in these competences and the outsourcing of those functions which do not meet these three criteria. A useful supplement to this line of thinking is that in a dynamic world, core competences can easily become core-rigidities (Leonard-Barton, 1995), and part of the task of upgrading is to relinquish areas of past expertise.

Closely related to this is a school of thought focusing on dynamic capabilities (Teece and Pisano, 1994). This literature explicitly builds on the concept of Schumpeterian rents discussed in the previous section. It argues that corporate profitability in the long run cannot be sustained by control over the market (for example, through using quasi-monopolistic practices), but through the development of dynamic capabilities which arise as a result of:

- its internal *processes* which facilitate learning, including the capacity to reconfigure what the firm has done in the past
- its *position*, that is its access to specific competences either within its own activities, or those which are drawn from the regional or national system of innovation
- its *path*, that is, its trajectory, because change is always path-dependent.

Both of these related concepts provide an important backdrop for understanding the phenomenon of upgrading. They are especially helpful in understanding the factors which both drive and facilitate improvements in product and processes which arise from the activities of the firm itself. But they are also weak because they stop at the level of the firm, and fail to capture upgrading processes which are systemic in nature and which involves groups of firms linked together in value chains. This is particularly damaging for the core competences approach which explicitly neglects the chain through its normative conclusion that upgrading almost always involves outsourcing.

Consequently, we need to view the upgrading challenge in a wider perspective, capturing the central idea that it may involve changes in the nature and mix of activities, both within each link in the chain, and in the distribution of intra-chain activities. This relates both to the achievement of new product and process development, and in the functional reconfiguration of who does what in the chain as a whole. It is thus possible to identify four trajectories which firms can adopt in pursuing the objective of upgrading, namely:

- **Process upgrading:** increasing the efficiency of internal processes such that these are significantly better than those of rivals, both within individual links in the chain (for example, increased inventory turns, lower scrap), and between the links in the chain (for example, more frequent, smaller and on-time deliveries)
- **Product upgrading:** introducing new products or improving old products faster than rivals. This involves changing new product development processes both within individual links in the value chain and in the relationship between different chain links
- **Functional upgrading:** increasing value added by changing the mix of activities conducted within the firm (for example, taking responsibility for, or outsourcing accounting, logistics and quality functions) or moving the locus of activities to different links in the value chain (for example from manufacturing to design) (Figure 10)
- **Chain upgrading:** moving to a new value chain (for example, Taiwanese firms moved from the manufacture of transistor radios to calculators, to TVs, to computer monitors, to laptops and now to WAP phones)

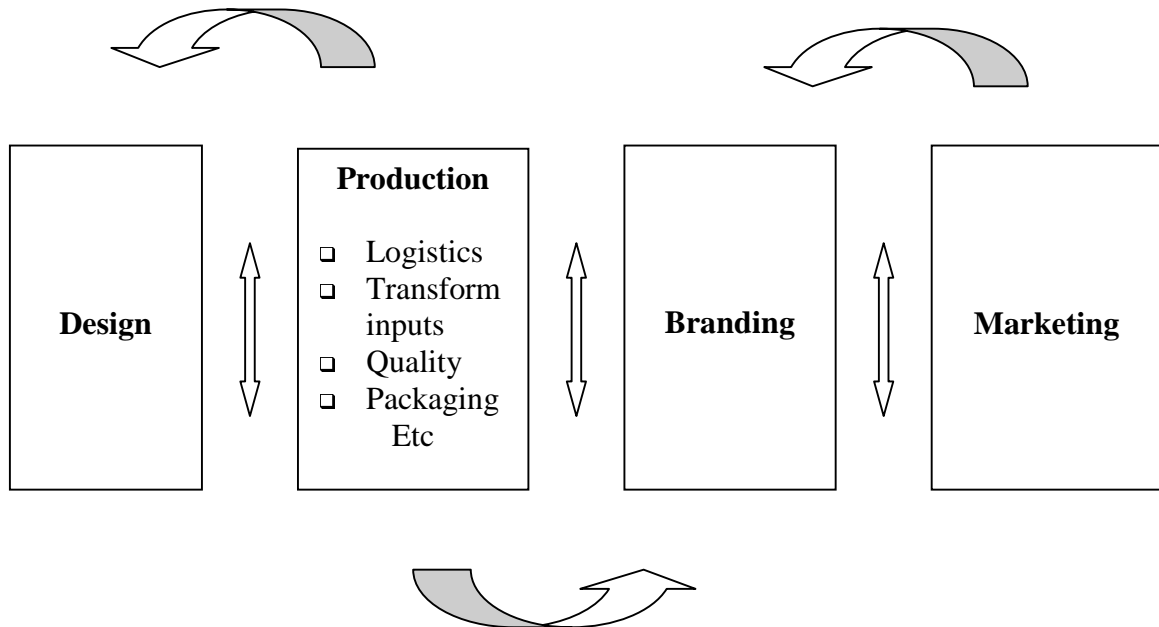
Figure 10: Functional upgrading in the value chain

Functional upgrading is changing the mix of activities within and between links

Is it possible to determine a hierarchy of upgrading? That is, does international experience suggest that firms engaging on an upgrading path are advised to proceed along a well-trodden path? Much of the literature indeed posits such a trajectory (Gereffi, 1999, Lee and Chen 2000). It is one which begins with process upgrading, then moves to product upgrading, to functional upgrading and last of all, to chain upgrading (Figure 11). This accords with the common assertion that East Asian firms have made the transition from OEA production (original equipment assembling, that is, thin value added assembling under contract to a global buyer) to OEM (original equipment manufacturing manufacturer, that is manufacturing a product which will bear the buyer's badge), to ODM (own design manufacturer) to OBM (own brand manufacturing). Invariably this is a trajectory which involves a progressively higher content of disembodied activities.

Figure 11. Is there a hierarchy of upgrading?

	Process	Product	Functional	Chain
Trajectory				
Examples	Original equipment assembly (OEA) ↓ Original equipment manufacture OEM	Original design manufacture	Original brand manufacture	Moving chains – e.g. from black and white TV tubes to computer monitors
Degree of disembodied activities	Disembodied content of value added increases progressively 			

Guide Questions 6

- How is innovation distinguished from upgrading?
- What are the primary forms of upgrading in value chains, and can these be distinguished from upgrading in individual firms?
- Is there a hierarchy of upgrading, and if so, can firms jump stages?
- Can firms sustain upgrading without moving through this hierarchy?
- Is a focus on core competences and outsourcing a necessary condition for sustained upgrading?

Reading

Humphrey, J. and H. Schmitz, (2001), “Governance in Global Value Chains”, in G. Gereffi and R. Kaplinsky (eds.), *IDS Bulletin*, Vol. 32, No. 3.

Gereffi, G (1999), “International Trade and Industrial Upgrading in the Apparel Commodity Chain”, *Journal of International Economics*, Vol. 48, No. 1, pp 37-70.

Lee, J. and J. Chen (2000), “Dynamic Synergy Creation with Multiple Business Activities: Toward a Competence-based Growth Model for Contract Manufacturers”, in R. Sanchez and A. Heene (eds.), *Research in Competence-based Research, Advances in Applied Business Strategy Series*, Vol. C, JAI Press.

6 VALUE CHAIN ANALYSIS AND THE DETERMINANTS OF INCOME DISTRIBUTION¹³

In Part 1 we observed that as globalisation has proceeded, so the patterns of inter-country and intra-country income distribution have become more complex, and that, in general, indexes of poverty (especially in its relative meaning) have worsened. In particular,

there has been a lack of correspondence between the growing global spread of economic activities associated with meeting global needs and the incomes which arise from these activities.

Value chain analysis can help to explain this growing disjuncture between the global spread of activities and incomes, particularly in a dynamic perspective. First, by mapping the range of activities in the chain it provides the capacity to decompose total value chain earnings into the rewards which are achieved by different parties in the chain. The value of this mapping exercise should not be underestimated, because no other form of analysis provides this synoptic overview of earnings (both international and intranational) in globally linked activities. Other ways of viewing global distributional patterns provide only partial insights into these phenomena. For example, trade statistics only provide data on aggregate, gross returns rather than on net earnings, and branch-specific analyses (agriculture, industry, services) only capture part of the story. Secondly, a value chain perspective analyses the way in which particular firms, regions and countries are linked to the global economy. This mode of insertion will determine to a large extent the distributional outcomes of global production systems and the capacity which individual producers have to upgrade their operations and thus to launch themselves onto a path of sustainable income growth. This is really important in understanding the dynamics of income distribution over time. And, thirdly, at the same time, by focusing on the institutions which drive international specialisation, value chain analysis identifies the normative levers which can be used to alter these distributional patterns. Let us consider each of these in turn.

6.1 Mapping distributional outcomes in the value chain

As we have seen in Section 2 above, the concept of rent provides an important analytical vehicle to explain why some activities in the chain are well-rewarded and others are not – the central part of this story lies in the determination of barriers to entry which limit competitive pressures. The analytical heritage which is brought to bear in the discussion of rent is that of Ricardo, Marshall and Schumpeter, each of whom puts the spotlight on the *entrepreneurial* function in production. From this it is natural that in mapping the distribution of income we focus on *profits*. The greater the barriers to entry, the higher the level of profitability. A good example of those for many years was that of the Pilkington Glass Company. It controlled the float-glass

¹³ In drafting this section we have greatly benefited from discussions with Adrian Wood and from his background note to the IDS Workshop on Spreading the Gains from Globalisation held in September 1999 (Wood, 1999).

technology which dominates the industry, and for many years, experienced years of high profitability.

So, profitability is an important window into understanding the pattern of returns in global production networks. But its limits can be seen from the experience of the fruit and vegetable global value chains (Kaplan and Kaplinsky, 1998; Dolan et. al., 2000). In both cases competitive pressures are high throughout the chain, including in the UK retail sector where a recent Government report has concluded that profit rates are below industry norms. The “surplus” here is a consumer surplus, not a “producer surplus” accruing to capitalists in the form of profits. So, if none of the entrepreneurial functions are earning monopoly rents, what can a focus on profits say about the distributional outcomes to global production systems?

The answer is very little, and it is for this reason that we need to focus not just on rates of return to entrepreneurship but also to other factors. Thus,

the distributional outcome in global value chains is to be seen in the incomes arising to capital (for its entrepreneurship, risk-taking and ownership of technology), labour (for its effort), and to the owners of natural resources (for their command over inputs which arise as gifts of nature) in each of the links in the value chain.

The key to understanding distributional outcomes is to be found in a focus on the incomes which are sustained in different parts of the chain, rather than on profits. Two important subsets of this conclusion need to be borne in mind (and we shall return to them in the methodological section which follows in Part 3):

- Insofar as we are concerned with sustainable incomes, these may be computed by the ratio of “output” to employment. But, in this case, we need to focus on the *value added* (that is output value minus input costs) rather than the gross value of sales/exports in each link of the value chain. The reasons for this are obvious – for example, a buyer near the apex of the value chain may account for only a small portion of total chain value added, but will have a very large share of the value of turnover
- However, although the “average” incomes sustained in any particular link in the chain may help in mapping the locational distribution of returns (for example, those between horticultural growers in East Africa and those in a rich countries retail sector), it does little to tell us about the *distributional outcomes within any particular link of the chain or any particular location*. These incomes therefore need to be decomposed, and here which decomposition is involved reflects the focus of enquiry. For example, it may be what economists call a functional decomposition (between labour and capital), or perhaps a gender division, a mapping of age-related earnings, ethnic earnings, or the division between skilled and unskilled workers.

6.2 Understanding the determinants of income distribution in value chains.

After mapping the incidence of income distribution, we also need to understand the determinants of income distribution. This requires a focus on rents and barriers to entry (as discussed above in 4.1.1). To repeat an earlier observation, where levels of competition are high, incomes are under threat. The only way in which income growth can be sustained is through an enduring barrier to entry or - where barriers to entry are transient - by the firm, the region or the country developing the dynamic capability to systematically move to activities in which high barriers to entry prevail.

Value chain analysis provides a direct line of entry into identifying the nature and extent of these barriers to entry along the chain. By focusing on the nature of entry barriers in each of the links, as well as on the coordination of inter-link activities (which give rise to relational rents), it is able to explain a significant part of the distributional outcomes arising from participation in global (and national) production systems. Moreover, it also provides a perspective for focusing on the *dynamics* of entry barriers, and carries the perspectives on core competences and dynamic capabilities considerably further forward by also considering the rents which accrue from *inter-firm relationships* (see 4.1.1 above). These may be referred to as “endogenous” rents or entry barriers, that is, those created directly by participants in the value chain itself.

But there are also a series of entry barriers, related to global value chain dynamics, but which are largely exogenous to the activities of the chain (Box 5 above). For example, firms in a particular locality may gain from “externalities”, that is, from the presence of other firms or skills which aids their efficiency. Recognition of the importance of these industrial districts has grown in recent years, not just in relation to richer countries (Pyke and Sengenberger, 1992), but also in developing countries (Nadvi and Schmitz, 1999). A second type of exogenous entry barrier lies in the realm of trade policies, either by protecting producers from import competition, or by providing preferential access to final markets. For example, until very recently, EU trade policies provided rents to firms producing bananas in the Caribbean rather than Central America, outweighing the “natural resource rents” which led the Central American producers to grow a superior product. A third, and perhaps one of the most important factors explaining patterns of global inter-country income distribution, are controls against immigration. It is for this reason that incomes in rich country supermarkets are higher than those in the East African farm producing the vegetables they sell. The supermarkets themselves have to be located in rich countries, but the wages of these workers are protected by immigration controls and are defined by the incomes of workers in the broader economy which result from complementary economic activities external to the chain.

However, the distinction between determinants to barriers to entry which are endogenous and exogenous to the chain is not as clear as it might seem. In many cases, purposeful action by influential chain participants might result in the establishment of exogenous entry barriers – for example, firms may lobby for protection, or may pressure local governments for better infrastructure. Similarly, exogenous factors may lead to the creation of endogenously-determined entry-barriers – for example, efficient government may introduce policies which assist firms to

develop dynamic capabilities, engage in supply chain development activities or to reposition themselves in the chain.

6.3 Levers of power in value chain dynamics

So, if value chain analysis can help us map the pattern of income distribution and explain why these patterns are emerging, can it also help us understand what can be done to change these distributional outcomes? The answer is that it makes a major contribution here, and for four reasons. In the first place, a comprehensive focus on the different components of rent, encompassing both Schumpeterian and other forms of rent (Box 5), identifies which activities in the chain are able to sustain high incomes. Second, suitably utilised, the focus on barriers to entry in value chain analysis also enables us to understand the dynamics of these distributional outcomes, identifying activities which are subject to growing competition (for example, the physical transformation of inputs into outputs) and those where there are likely to be sustained or growing entry barriers in the future (for example, design and branding).

Thirdly, the focus in value chain analysis on power relations and institutions explains *whose* behaviour needs to change if different outcomes are to emerge. The factors which are used in production do not participate as individuals; they are grouped in institutions which develop path dependencies and tacit forms of knowledge and technological capabilities. For example, “skill development” through training programmes will in itself not be an adequate way of ensuring growing shares in global production networks. These skills have to be harnessed into teams, meeting focused objectives which can be realised in the market. These teams are simultaneously embedded in firms, which are in turn embedded in value chains. Again, each of these different parties possesses differential types and levels of power. So, if change is to result, these institutions, their capacities and their powers will all need to be addressed, and the value chain framework provides a comprehensive arena in which these challenges can be identified.

And, finally, value chain analysis does not stop at the level of the firm or groups of firms. It also draws attention to the national system of innovation – the network of institutions which support economic actors. What they do impinges on the competitive performance of firms and groups of firms, and is also subject to the support and regulation provided by governments, whose actions, too, need to be located in value chain analysis.

Guide Questions 7

- ❑ Why are profits alone not a suitable mechanism for mapping the distribution of returns in global production systems?
- ❑ Does the absence of high profits in a value chain mean that incomes are evenly spread globally? If not, what factors may in fact account for different incomes in the chain? How does this relate to the mobility of different types of labour?
- ❑ In what ways may value chain analysis help to unravel the processes which determine the spread of incomes in global value chains?
- ❑ How might this understanding of underlying processes assist in developing policies which might alter distributional outcomes?

Reading

Wood, A. (2001), "Value Chains: An Economist's Perspective", in G. Gereffi and R. Kaplinsky (eds.), *IDS Bulletin Special Issue on The Value of Value Chains*, Vol. 32, No. 3, pp. 41-6.

Kaplinsky R (2000), "Spreading the gains from globalisation: What can be learned from value chain analysis?", *Journal of Development Studies*, Vol. 37, No. 2., pp 117-146

7 HOW DOES VALUE CHAIN ANALYSIS DIFFER FROM CONVENTIONAL INDUSTRY STUDIES AND FROM WHAT SOCIAL SCIENTISTS (AND ESPECIALLY ECONOMISTS) NORMALLY DO?

Traditionally, the focus on productive activities and the insertion of local producers into global markets has been on the economic branch and the economic sector. Developing countries have been seen to have a potential comparative advantage in the primary branch, and the industrial countries in secondary economic activities and value-added traded services. Within the industrial branch, the focus has most often been on individual sectors (based on ISIC or SITC/HS classifications) such as clothing, shoes, chemicals, electronics, food processing, and in a national context. Hence, the analysis has tended to focus on the size and growth of the sector in terms of employees and gross output (rather than net value added), trade performance and the size distribution of firms.

Value chain analysis throws more light on the determinants of income distribution, both within and between countries, and especially over time than this traditional industry analysis. For example:

- Because it focuses on the dynamics of rent, a value chain perspective forces the analysis to transcend economic branches and sectors. For example, in the forestry and furniture chain, the rent-rich activities are increasingly found in the genetics of seed design and in the design and branding of the furniture, rather than in the individual agricultural, industrial or service sub-sectors (which tend to be the domain of traditional branch and sectoral analyses). It is only through a comprehensive view of the whole chain *that the links in the chain or segments in product markets which are characterised by high or growing rent can be identified.*
- Related to this, value chain analysis makes it possible to trace through a particular thread of *rent-rich activities* which are not easily captured by branch and industry analysis. For example, we have observed that intangible knowledge is increasingly characterised by high barriers to entry, and that the owners of this knowledge gain most from the globalisation of production and exchange. Similarly, in addition to imposing barriers to entry, governance may itself often be subject to significant barriers to entry and hence provide high returns. This being the case, the ability to identify rent-rich activities along the whole chain of added value provides the key to understanding the global appropriation of the returns to production.
- The *data* which are characteristically generated in most branch and sectoral analyses make it difficult to interpret the significance of key indicators such as “output”, “sales” and “costs”. Consequently the determinants of income distribution are difficult to unravel. Trade statistics are especially problematic here, since they provide little capacity to unpick value added. For example, in the late 1980s, the Dominican Republic saw a significant increase in the gross value of shoe output and exports. But “shoe production” occurred in EPZs utilising

imported inputs – the unit value of a shoe export was a mere \$0.23. By contrast unit shoe exports from Italy may more fully reflect value added. In what senses, then, may the shoe sectors in these two countries be compared unless a value chain analysis – incorporating a more sophisticated mapping of input-output relationships - is utilised?

- The dynamic nature of rents generated in the global activities of a value chain are *obscured by a focus on national industries*. For example, when production occurs in the context of falling global product prices, national accounting systems may reflect a growth in activity and value which does not correspond with the international purchasing power of this sectoral activity. The problem is particularly acute when decisions about *national* resource allocation – affecting income streams over time – are made without reference to the *global* dynamics of returns to different activities in the chain. Thus it is the global focus of value chain analysis which more accurately identifies suitable opportunities to augment incomes in a national context than the national focus of industry studies.
- Studies of market structure which fail to locate the analysis within a value chain perspective are not able to adequately explain the *determinants of firm-size distribution*. For example, the high concentration of ownership in the South African furniture industry does not arise from market conduct within the furniture sector. Instead, it is explained by high levels of concentration in the retail sector, which in turn is linked to concentration in financial intermediation (Kaplinsky and Manning, 1998). Similar observations have been made with respect to the footwear industry, but in this case the inter-sectoral linkages which are involved span national boundaries (Schmitz and Knorringa, 1999).

So much for the content of research enquiry. But what of the implications for disciplinary focus?

- Because value chain enquiry spans different economic branches and sectors, effective analysis requires the participation of different disciplines. This is most clearly the case in relation to the focus on agricultural and manufacturing production systems, but the focus on the dynamics of rent also requires inputs from management studies and engineering. Moreover, since power is a key component of governance, and trust is critical to enhanced inter-firm cooperation and new forms of work-organisation, there is a simultaneous need to draw on the insights of political science and sociology. It is for this reason that Wood reflects that value chain analysis provides “a *meeting ground* for economics, business administration and industrial sociology in the study of one important aspect of globalisation, namely the simultaneous economic integration of countries, and disintegration of production processes” (emphasis added) (Wood, 2001:41).
- A number of challenges are posed to much of traditional *economic analysis*. The Heckscher-Ohlin factor-price equalisation theorem predicts that in an open economy, factor returns such as wages will tend to converge across (and within some) national boundaries. Yet, this is often not the case, in part due to the falling costs of mobility as highly skilled workers, operating within coordinated value chains, interact with skilled and unskilled workers in different economies (Wood, 1999). The ability to identify and capture the role played by these mobile skills is

significantly enhanced when analysis occurs through the lens of the value chain. Much economic analysis of income distribution also tends to focus on the individual as the unit of account, and it is certainly the case that incomes do accrue to individual people as holders of assets (for example, skills and equity). Yet, while individuals may receive incomes, these returns are defined by their participation in institutions (that is, firms) which systematically pursue policies designed to enhance these incomes by constructing barriers to entry against competition. Understanding the processes whereby barriers to entry are constructed takes the analysis beyond the domain of much of economic analysis which treats technological progress as exogenous, and fails to recognise the ability of firms to construct the competitive environment in which they operate (rather than acting as price-takers). Moreover, an understanding of the nature and importance of trust in inter-firm relationships within the value chain requires economists to also engage with the contingency and sociology of the determinants of social capital.

- In a similar way, other disciplines are also forced to rethink their analytical frameworks by a focus on value chains. Wood argues that economics not only provides an accounting framework in which value chains can be mapped, but also forces the enquiry to focus on the economic determinants of location, notably on cost structures (Wood, 1999). Thus, a (complementary) division of labour can be characterised as one in which economists determine the basis of *comparative advantage* (that is, the potential which different environments provide for reaping economic rents), and other disciplines identify the determinants of *competitive advantage* (the factors which explain why some firms are able to appropriate these economic rents).

PART 3: A METHODOLOGY FOR UNDERTAKING VALUE CHAIN RESEARCH

The world of production and exchange which we are observing is complex and heterogeneous. Not only do value chains differ (both within and between sectors), but so, too, do national and local contexts. So there is no mechanistic way of applying value chain methodology. Each chain will have particular characteristics, whose distinctiveness and wider relevance can only be effectively captured and analysed through an understanding of the broader issues which are involved. Consequently, to be useful, the methodology which follows needs to be read in the context of the theoretical discussion in previous parts of this Handbook.

The methodology outlined in following sections will address the following issues, and begins with understanding the nature of final markets, which are increasingly the driver in many value chains:

- The point of entry for value chain analysis
- Mapping value chains
- Product segments and Critical Success Factor's in final markets
- How producers access final markets
- Benchmarking production efficiency
- Governance of value chains
- Upgrading in value chains
- Distributional issues:

This methodological discussion tries to synthesise the methods of enquiry used in a diverse number of studies, not all of which explicitly focus on value chain research. Each of these studies reflects the contingent circumstances of the research investigation, mirroring the resources available to the researchers, their skills, and probably most critically, the quality of their access to the subjects of the research. It is unlikely, therefore, that any single value chain study will be able to fully utilise this diverse set of methodologies set out below. Moreover, individual research projects have specific foci - perhaps on income distribution, or employment, or gender relations - in which case there may be no need for a comprehensive research agenda. Finally, the methodological discussion which follows is presented only in outline form, and may be an inadequate guide for more detailed and specific enquiry. Consequently, what follows should be read and used selectively. We have tried to structure the discussion in such a way that we provide the reader with a general starting point for more detailed levels of enquiry.

8 THE POINT OF ENTRY FOR VALUE CHAIN ANALYSIS

As we saw in earlier sections, value chains are complex, and particularly in the middle tiers, individual firms may feed into a variety of chains. Which chain – or chains – is/are the subject of enquiry therefore very much depends on the point of entry for the research inquiry. Figure 12 lists some possible points of entry, reflecting concerns with:

- the global distribution of income
- retailers
- independent buyers
- key producers
- sub-suppliers
- commodity producers
- agricultural producers
- small farms and firms
- informal economy producers and traders
- women, children and other marginalised and exploited groups

In each case, the point of entry will define which links and which activities in the chain are to be the subject of special enquiry. For example, if the focal point of the enquiry is in the design and branding activities in the chain, then the point of entry might be on design houses, or the branding function in key global marketing companies. This will require the research to go backwards into a number of value chains which feed into a common brand name (for example, the different suppliers to Nestles, or to The GAP). At the other end of the scale, a concern with small and medium sized firms, which feed into a number of value chains, might require the research to focus on final markets, buyers and their buyers in a number of sectors, and on a variety of input providers.

Figure 12: Some examples of different points of entry into value chain research

Primary area of research interest	Point of entry	What to map	Examples
The global distribution of income	The final consumer (and recycling) in a sector	Backwards down whole chain to retailers, buyers and producers	In furniture, begin with groups of customers of department and specialist stores in rich countries
Role of retailers	Supermarkets or retail chains	Forwards to type of customer, backwards through buyers, producers and their suppliers	In food, begin with supermarkets
The role of independent buyers	Independent buyers, wholesalers	Backwards to producers and their suppliers in same chain, forwards to retailers	In shoes, begin with specialist buyers, in fruit and vegetables with category buyers
Design	Independent design houses, advertising agencies or large firms with global brands	Forwards to retailers in various final markets, backwards to variety of producers and their suppliers	In clothing, begin with Prada and the GAP in the volume markets and to Gucci in Haute Couture markets
Role of key producers	Large OEMs assembling final products	Forwards to retailing, backwards to suppliers and their suppliers	In autos, Ford; in consumer electronics, Sony
First tier suppliers	Large firms providing sub-assemblies to OEMs	Forwards to OEMs and their customers, perhaps in more than one sector; backwards to suppliers and their suppliers	In autos, Magna and Delphi; in computers, with motherboard and monitor manufacturers
2 nd and 3 rd tier suppliers	Generally small firms	Forwards to customers in a variety of sectors, backwards to suppliers and their suppliers	In food, to firms printing packaging materials; in banking to providers of software modules
Commodity producers	Generally large firms	Forwards to producers, buyers and final markets and backwards to machinery and input suppliers	In copper, to major buyers at London Metal Exchange and to suppliers to the telecoms sector
Agricultural producers	Farms	Forwards to processors, buyers and their customers, backwards to input suppliers	Fresh vegetables to salad packers and category buyers in final markets
Small firms and farms	Small farms, industrial SMEs	Buyers in a range of value chains, input suppliers	Handicraft suppliers to exporters, small farms to processing plants
Informal economy producers and traders	Home based workers, street traders	Forwards to processors, assemblers or third party organisers/distributors, backwards to retailers	Outsourcing in clothing and shoes, recycling cardboard cartons to mills, street based tourist handicrafts
Gender, age and ethnicity	Female labour	Use of female labour throughout value chain	In clothing, women in cotton farms, factories, export agents, design houses, advertising agencies, retail stores

Once the point of entry is defined, one of the problems which arises is that the theory of value chains suggests simplicity and an easy clarity of focus. However, the real world can be much messier, as Figure 13 suggests, and the researcher will sometimes have to make arbitrary decisions on what to map in charting a path through complex value chains.

Figure 13: Value chain mapping: Theory and reality

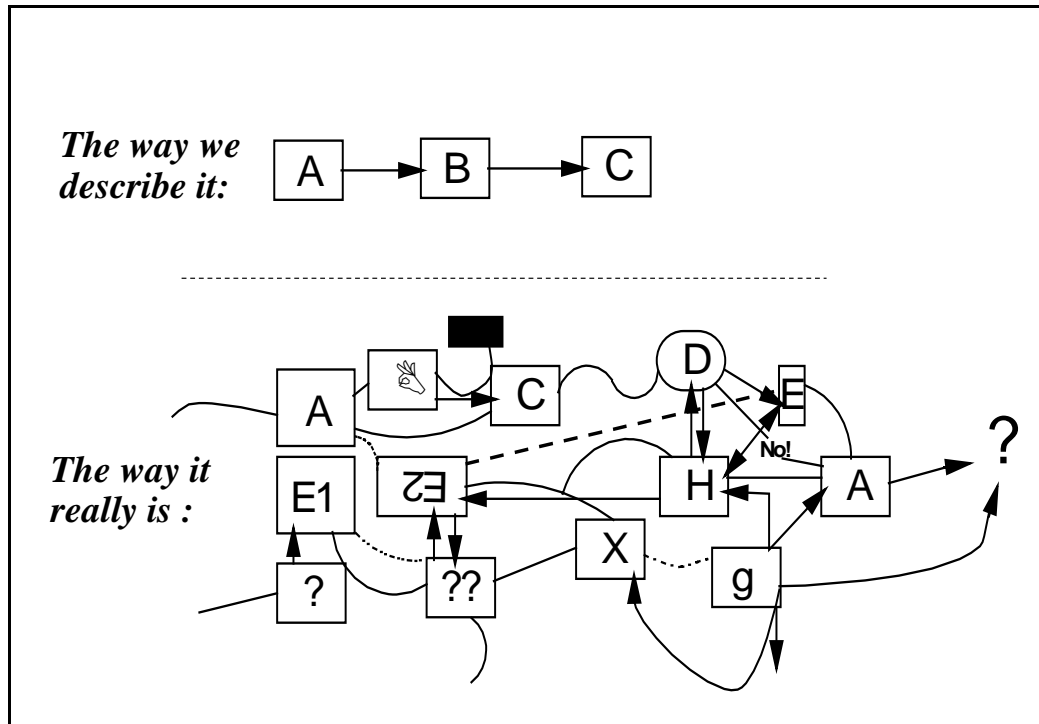

Source: Brown, Bessant and Lamming 2000

9 MAPPING VALUE CHAINS

Having identified, the value chain in question, the task is then to put numbers and values to the variables under investigation. Here, which variables are chosen will reflect the primary questions being addressed in the research – for example, as we shall see below, a gender focus may suggest that a *specific* gender-lens be utilised to collect issue-specific data which identify the role played by women throughout the chain. But, leaving aside these specific interests, it is likely that all value chain analysis will gain from constructing a “tree” of input-output relationships which include most of the following primary *general* accounting identities:

- gross output values
- net output values (that is, gross output, minus input costs)
- the physical flow of commodities along the chain
- the flow of services, consultants and skills along the chain
- employment, where relevant distinguishing between permanent (on payroll) and temporary (off payroll) staff, gender, ethnicity
- destination of sales - for example to wholesalers and retailers; concentration of sales amongst major buyers; number of buyers
- imports and exports, and to which region

In collecting these data it will generally be important to generate data over time, showing the trajectory of change as well as the position in any one point in time. Generally, the preceding five years will provide an adequate dynamic picture, but this depends on the research question being pursued.

Obtaining gross output values is a relatively simple task – for example, Table 3 shows the build-up of output values in the canned deciduous fruit sector in South Africa. These data can easily be obtained from key respondents in each link of the chain, since it only involves measuring output values (per unit, that is per tin, per kg of sugar, per crate of canned fruit, fob values per crate, and final supermarket prices). This can be done by dividing total sales by numbers of units produced. It is also relatively easy to measure the number of people employed in each link in the chain, particularly if there is no need to decompose this labour force into skill or gender groupings. Data on customers and imports and exports are generally also readily available from the finance and/or the sales offices of the firm or farm in question.

Table 3: Breakdown of canned peach value chain

Stage in value chain	Contribution to final product value (%)
Within South Africa:	
Peaches	12.4
Cans	11.6
Sugar	4.2
Canning	14.7
Labour	7.4
Other (e.g. depreciation, utilities, profit, internal transport)	<u>7.3</u>
Total inside South Africa	42.9
Outside South Africa	
Shipping, duties, insurance, landing charges	24.2
Importer's margin	6.3
Supermarket margin	26.7
Total outside of South Africa	57.1

Source: Kaplan and Kaplinsky, 1998

Figure 14 gives some suggestion of what sources may be used in obtaining this general data.

Figure 14: Sources for primary accounting data

Primary accounting data	Where to find data	Calculation required
Gross output values	Annual report/balance sheet; interview with CEO or finance officer	Record turnover figures
Net output values	Balance sheet; interview with finance function	Gross sales minus purchases of incoming materials and components
Physical flow of commodities	Outgoing volumes from production control, incoming volumes from inventory control and/or purchasing dept.	Tonnes, metres, litres, etc.
Flow of services, consultants and skills	Interviews with finance function, purchasing dept.	Payments for bought-in services and skills
Employment	Personnel dept.	Numbers employed, permanent and casual, gender
Destination of sales	Sales office	% of sales going to different types of customers and markets; number of customers
Imports and exports	Sales office for exports, purchasing office for imports	% of sales going to domestic and different foreign customers, % of imports from domestic and different foreign suppliers

10 PRODUCT SEGMENTS AND CRITICAL SUCCESS FACTOR'S IN FINAL MARKETS

One of the distinctive features about contemporary production systems is that they tend to be “market-pulled”, as opposed to the “supplier-push” nature of protected and low-competition value chains in previous decades. This puts a primacy on the characteristics of final product markets in every chain, and generally represents a high-order priority in all value chain studies.

At the very least this will require a mapping of market size and market growth. But, although to some extent this depends on the focal point of the research, it will almost always be important to decompose the final market in the value chain into different market segments. Prior to the 1970s in the industrialised countries, and until the demise of import substituting industrialisation in developing countries, markets were relatively homogeneous. The key challenge facing the producer was to provide adequate volumes into supply-constrained markets. Before supply capabilities began to exceed market demand, and where competition was rife, the “winning” selling point was generally price. But in the last quarter of the 20th century, as supply capabilities generally began to exceed effective demand, markets became much more demanding as competitive pressures increased.

Contemporary global markets comprise a number of key characteristics which will need to be analysed to understand value chain dynamics. The critical components are that:

- They are *segmented*. For example, in foodstuffs they comprise low income processed foods, convenience foods, organic foods, exotics, ethnic products and so on. Each of these markets will have its own distinctive market characteristics, and together with market size and growth, these will need to be documented.
- These market characteristics are referred to as *Critical Success Factors* (CSFs). Generally, in low income final markets, price will be a relatively important CSF, but it will not be unique. Customers will also require quality, differentiation and branding. In higher income final markets these non-price CSFs will generally be relatively more important, with innovation, customisation and quality dominating. In intermediate markets (for example for components), firms may feed into a variety of chains serving the needs of different final market segments. So, for example, when they feed auto components into cars for high income markets, they will be required to produce in small volumes, to make small deliveries and to reach high levels of quality. By comparison, assemblers selling into the budget, mass-market may be more concerned with price, and may prefer larger volumes of relatively standardised components.
- Not only are markets increasingly segmented, with each segment having distinctive combinations of CSFs, but they are also *increasingly volatile*. They change rapidly. For example, even in mass markets in the global clothing industry, the number of seasons has grown from two (winter, summer) to four (winter, spring, summer, autumn) and now to eight (early and late summer, and so on). One Spanish retailer (Inditex) with more than 1,000 stores in 30 countries and a

turnover of around \$2bn, has now moved to a 52 season year. It produces a new range of clothes every week; and each of its stores will change its stocks on a weekly basis (Financial Times, 26/10/2000: 18).

- The Critical Success Factors in each market can be readily grouped into those factors which are “*order qualifying*” (that is, producers need to achieve these in order to participate in these markets), and those which are “*order winning*” (that is, these are the critical factors which lead particular firms to succeed, perhaps by selling at a price premium). Table 4 provides an example of the difference in order-winning characteristics in Europe, the USA and Japan in 1997. One of the interesting features of this table is how low customer fulfilment was rated in Japan – this is because having achieved this in the early 1990s, it became an order-qualifying criterion, with the “winning” attribute being product innovation. By contrast, in Europe and USA where firms were still catching up to Japanese levels of product quality, customer fulfilment was regarded as the order-winning CSF.

Table 4: Different perceptions of market requirements: America, Europe and Japan

EUROPE	USA	JAPAN
Customer fulfilment	Customer fulfilment	Introducing new products
Introducing new products	Introducing new products	Transforming physical materials
Product support	Product support	Procurement
Transforming physical materials	Procurement	Product support
Procurement	Transforming physical materials	Customer fulfilment

Source: de Meyer et al (1996).

How can these different market characteristics be researched? For those researchers having access to on-line search capabilities or to well-served libraries, a first port of call are a range of reports which are prepared by consultancy firms. For example, in the auto industry, one source (Automotive World) provides more than 100 reports dealing inter alia with

- Global Automotive Components Report: A strategic review of markets, players and prospects (\$842)
- The Car Aftermarket in Europe: Winning strategies for a new era (\$842)
- World Tyre Industry Forecasts and Trends (\$332)
- Managing the Future: World Vehicle Forecasts and Strategies to 2020; Volume 1 - Changing Patterns of Demand (\$1,012), Volume 2 - A Market by Market Review of Global Demand (\$1012).

Similar series of reports are available on virtually every industry, some specific to market conditions in particular countries and regions, others offering insights into global markets.

But for many researchers, these reports are too costly. Moreover, they are often “thin”, compiling information from annual reports and newspapers which are widely available. An alternative source of information to these reports, providing information at about the same level, is derived from mining the internet. Although it cuts out the problem of cost, the problem of ‘thinness’ generally still remains. It may therefore be necessary to undertake primary research into these issues with key informants. Suggested entry points into the collection of these data are shown in Figure 15.

Figure 15: Primary research on market characteristics

Market characteristics	Data Sources	Key respondents
Market segmentation	Industry consultancy reports; interviews with retailers and major final producers in the chain; industry associations	Consultants; buyers in retailers; sales managers in producers
Critical Success Factors	Undertake CSF analysis (see below)	Buyers in retailers; sales managers in producers
Order-qualifying and order-winning characteristics	Undertake CSF analysis (see below)	Buyers in retailers; sales managers in producers
Market volatility	Industry consultancy reports; interviews with retailers and major final producers in the chain; industry associations	Consultants; buyers in retailers; sales managers in producers

For primary research, a useful tool for conducting analysis of CSFs and order-qualifying and order-winning characteristics is through the use of scored responses on a 1-10 or 1-7 scale.¹⁴ The first step is to undertake a limited number of pilot interviews to get a feel for the CSFs in a particular market or market segment. These will vary by sector. For example, perishability may be an issue in food products, but not in electronics or banking services. Thereafter, key respondents should be asked how important each of these CSFs are in each of the key market segments, using a scale of 1 (not important) to 7 or 10 (extremely important). Experience suggests that each of these scaling points needs to be described briefly (Figure 16), otherwise respondents seldom utilise the bottom of the range. The same CSFs should be utilised in each segment of a sector market to facilitate comparison between segments, but respondents should also be offered an “other category” to write-in CSFs not provided to them. A list of CSFs specific to the automobile components and clothing sectors in the South African final market is provided in Figure 16.

¹⁴ Experience from working with firms suggests that a 1-5 scale does not provide sufficient scope for nuanced responses. Most ordinary people think in percentages or decimal places, hence a scale of 1-10, but an odd-number scale may be more suggestive of nuancing than an even-numbered scale.

Figure 16: Assessing the relative importance of CSFs in the auto components and clothing sector in South Africa

Industry specific CSFs		1	2	3	4	5	6	7
Auto components	Clothing sector	Not Important		Moderately important		Fairly important		Critically important
Quality	Quality							
Price	Price							
Delivery reliability	Delivery reliability							
Conformance to specification								
Packaging								
Flexibility	Flexibility							
Innovation	Innovation							
Financial stability	Financial stability							
	Responsive-ness							
Other:								

It is then possible to plot these responses on to a radar chart (easily done in Microsoft Excel), which provides a picture of these preferences, and is particularly useful in that it makes it clear that modern markets are characterised by multiple CSFs. For example, in many markets it may not be a matter of price or quality, but price *and* quality. Moreover, if both are scored high, there may be little trade-off between CSFs - that is, buyers may not be prepared to pay more for higher quality but may require both. Figure 17 provides an example of the pattern of CSFs in different segments of the clothing sector in South Africa, the upmarket AB and the downmarket CD sectors.

Figure 17: CSFs in upmarket and downmarket clothing sectors in South Africa

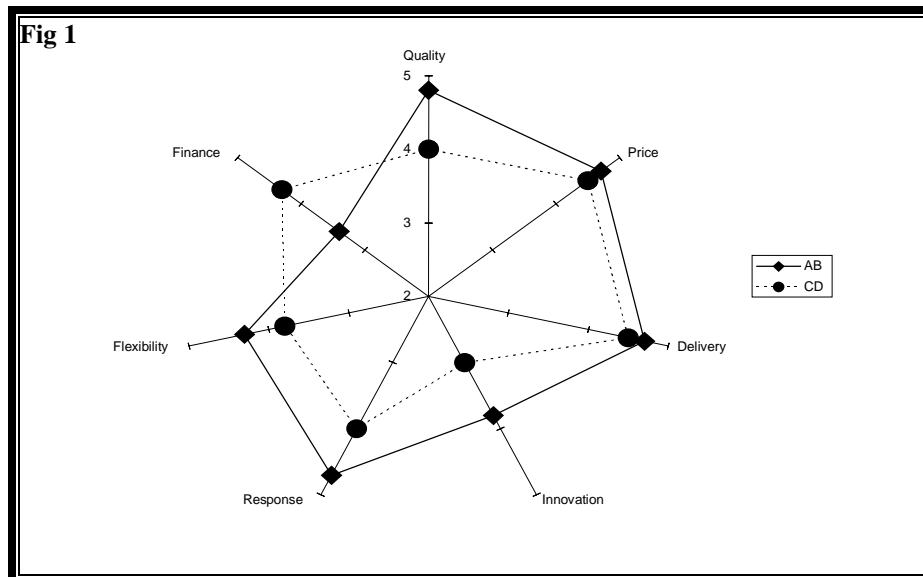

Source: Industrial Restructuring Project 2000

One of the key problems which emerges in collecting data involving qualitative perceptions of key informants is the issue of *triangulation*, that is, the means of verifying data which have been collected. (This is true of all data collection, not just on CSFs). Therefore, wherever possible, it is desirable to cross-check data. An

example of how this cross-checking methodology can be used can be drawn from this analysis of market characteristics. Here the same questions can be provided to both the suppliers and the buyers in a market transaction. This serves a dual function both of triangulating data and of assessing the capacity of producers to “hear” their final markets effectively, a precondition for value chain systemic efficiency (see below). In the case of the auto components study of CSFs shown in Figure 18 for example, the same data was sought from both buyers and sellers. It can be seen from this analysis that the suppliers tended to underestimate how demanding their customers CSFs really were, focusing on only a narrow range of criteria, namely quality, price, delivery reliability and conformance to standards.

**Figure 18. Perceptions of CSFs in South African auto components sector:
Supplier and buyer perceptions.**

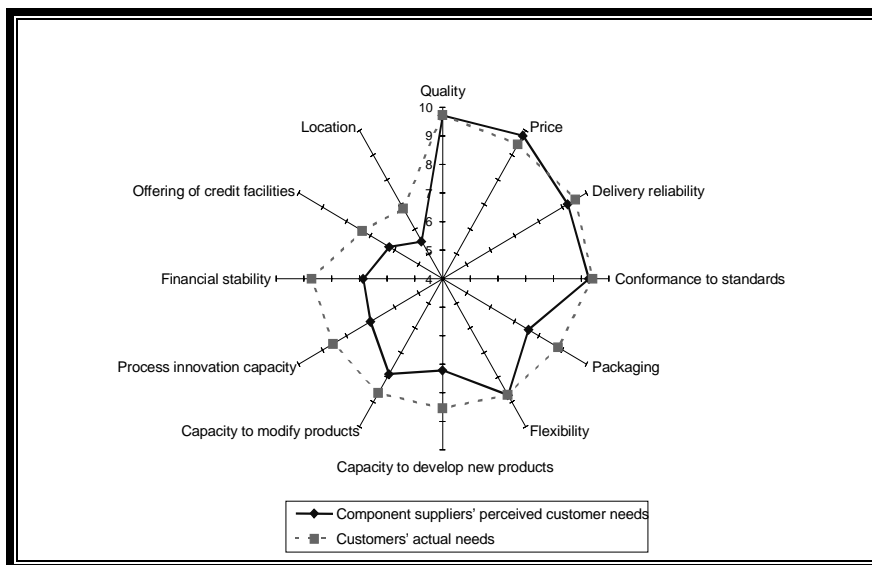

Source: Barnes, 2000

11 HOW PRODUCERS ACCESS FINAL MARKETS

As we saw in the theoretical discussion in Part II above, one of the powers of value chain analysis is that it goes beyond firm-level analysis. That is, a narrow focus on the competitiveness of individual producers, or indeed even a chain of producers, may not explain their success in global markets. This is because each of these producers needs a point of entry into global markets, that is they need to be connected. The point is that different forms of connecting intermediaries will affect the terms of entry into global markets and the capacity of individual producers to upgrade. In terms of orders of importance, therefore, knowledge of the ways in which disparate producers are connected into different final markets is of particular importance to value chain analysis; this links, as we shall see below, to the ability to characterise value chains as being either “buyer-driven” or “producer driven”

From the perspective of value chain analysis, the key issues to research are:

- The *identification of the key buyers* in a particular chain. In some cases these buyers might be at or close to final markets, particularly in those non-durable consumer goods industries which Gereffi characterises as “buyer-driven” sectors, such as clothing, food, toys and footwear. In other sectors, the major buying decisions may be made by the systems assemblers, for example the auto assemblers reaching agreements with first-tier global suppliers. But in other cases, markets may be more fragmented, such as in service sectors such as tourism.

There are different types of key buying institutions, the major forms being:

- Retail chains buying in large volumes
 - Wholesale firms (“category agents” in the food industry) buying in large volumes
 - Independent buyers, generally selling to small scale retailers
 - Large firms in key links of the chains which buy in large volumes and/or who set the rules (“legislative governance”) which govern incorporation in final markets
- The *dynamics of the buying function*. In many chains, the buying function is becoming increasingly concentrated. For example, even in the Italian, Japanese and Greek retail sectors, which have historically been dominated by small-scale producers, concentration levels are increasing rapidly, and so, too, therefore is the power of these buyers in the value chains in which they operate.
 - Having identified the key buyers, with an eye to the dynamics of the buying function, the next step is to *chart the CSFs* which these buyers exercise. In most cases these CSFs are defined by the market segments in which they operate, but often buyers in the same segments will nuance their requirements in particular ways. For example, in the oil extraction industry, BP and Shell will place

considerable emphasis on the environmental practices of their suppliers; whereas the large US firms in general (and Exxon in particular) have distinctively distanced themselves from these concerns.

- Linked to this, buyers will often *have strategic judgements about specific sources of supply*. They may favour particular regions – Africa, for example, may be seen as unreliable, or buyers may find it uncomfortable to travel to these regions. Or, they may prefer to source from particular ethnic groups, such as is reputed to be the case with overseas Chinese communities. Or they may feel at ease with particular languages, and so on. Identifying these preferences of buyers is an important component of this analysis.
- *Supply chain management* techniques have helped to upgrade systemic competitiveness. They are often linked to the durability of relationships between buyers and suppliers, which in turn is linked to the number of suppliers with whom buyers cooperate. The development of long-term and high-trust relationships generally require a smaller number of suppliers, so the number of, and the degree of concentration of key suppliers, are important data-sets. (Supply-chain management is essentially around the legislative elements of value chain governance discussed in Part II above)
- Related to this is the issue of *supply chain upgrading* (that is, executive functions in value chain governance). In some cases buyers might limit their efforts to rationalising their supply base and working to improve trust-relations over time. But in other cases, where supplier capability may be inadequate, buyers may provide inputs to assist their suppliers to upgrade their efficiency. They may do this directly, or through utilising ‘buying agents’ in the country in question. For example in the furniture sector, the UK based B&Q local buying agent in South Africa performs this function. But it may be as important to document the efforts which limit supply chain upgrading (as we saw in the case of buyers sourcing leather shoes from Brazil) as those which are designed to promote supply chain upgrading.

Figure 19 summarises some of the key data sets which are required to understand this issue of how producers are connected to final markets.

Figure 19: Analysing how producers are connected to final market

Issues in buying	Method of data collection	Data required
Identification of key buyers	Analysis of key market segments; ask suppliers for names of major buyers	Concentration ratios in market segments ^a ; names of key buying firms/individuals
Dynamics of the buying function	Analysis of key market segments; discussions with key buyers	Changing distribution of sales through different marketing channels
CSFs of different buyers	Interviews with key respondents	Use 1-7 CSF methodology discussed above; time trend of competitiveness of suppliers
Strategic judgements on sources of supply	Interviews with key respondents	Judgements of which supply sources are likely to be winners, and why this might be the case
Supply chain management policies	Interviews with key respondents, both amongst buyers and suppliers (to triangulate results)	Overview of strategic policy; number and concentration of suppliers; length of relationship with key suppliers; use of open-book costing ^b ; frequency and depth of communication between buyers and suppliers; frequency and nature of visits to and by suppliers, and who makes visits
Supply chain upgrading policies	Interviews with key respondents, both amongst buyers and suppliers (to triangulate results)	Specific steps taken to upgrade (or prevent upgrading) by suppliers; size and budget of supply chain management function in buyers; frequency and nature of visits to and by suppliers, and who makes visits

^a Useful forms of concentration-ratio calculations are the proportion of purchases coming from the three largest, the five largest and the 10 largest suppliers (three-firm, five-firm and 10-firm concentration ratios). Another analytical technique is Pareto-analysis, detailing the percentage of sales accounted for by the deciles of suppliers, which can then be charted on a graph.

^b Open-book costing refers to a relationship whereby the suppliers open their costing procedures to buyers so that they can jointly act to reduce costs in the belief that the buyers will not use this information to squeeze profits out of production. Where this works, open-book costing requires high levels of trust and long-term relationships, and frequently also involves some minor equity-holding.

12 BENCHMARKING PRODUCTION EFFICIENCY

Having charted the dynamic nature of final markets, and the ways in which producers are inserted into these markets, it is then necessary to analyse the productive efficiency of different parties in the value chain. This is referred to as “benchmarking”. The essential features of benchmarking are:

- *How to link benchmarking to wider issues?* Benchmarking is seldom important in its own right, it needs to be set against the challenges which confront the firm. Most often, these challenges are defined by the ability of the firm to meet the CSFs which it or its chain confronts in its final markets. These CSFs will of course vary, but Figure 18 provides an example drawn from the automobile components sector in South Africa, and has been widely utilised by the three KwaZulu-Natal, Eastern Cape, and Gauteng Benchmarking Clubs.¹⁵ The key drivers which this chain faces are:

- Cost competitiveness
- Quality
- Lead times to satisfy customer orders
- The capacity to make minor and frequent changes (through continuous improvement)
- The capacity to make more fundamental changes to products and processes

Meeting each of these market drivers requires operational practices, and will be reflected in performance outcomes; both these performance outcomes and practices can be benchmarked, against internal operations over time, and against competitors.

¹⁵ For more detail see www.kznbenchmarking.co.za.

Figure 20: The link between CSFs in the market to what is benchmarked in terms of practices and performance

Market drivers	Operational performance measures	Linked organisational practices
1. Cost control	Inventory use (raw materials, work in progress, finished goods)	Single unit flow, quality at source, cellular production, production pulling (kanbans)
2. Quality	Customer return rates, internal reject, rework and scrap rates, return rates to suppliers	Quality control structures, statistical process control, quality circles, team working, multi-skilling
3. Lead times (value chain flexibility)	Time from customer order to delivery, delivery frequency of suppliers and supplier delivery reliability, delivery frequency to customers and delivery reliability	Business process engineering, cellular structures in order processing and dispatch, value chain relationships and supply chain management
4. Flexibility (Internal operational flexibility)	Manufacturing throughput time, machine changeover times, batch and lot sizes, inventory levels, production flow	Production scheduling, JIT, single minute exchange of dies, multi tasking and multi skilling, cellular production in manufacturing
5. Capacity to change (Human resource development)	Literacy and numeracy levels, employee development and training, suggestion schemes, labour and management turnover rates, absenteeism rates, output per employee	Continuous improvement (kaizen), work organisation, worker development and commitment programmes, industrial relations
6. Innovation capacity	R&D expenditure (process and product), contribution of new products to total sales	Concurrent engineering, R&D

Source: Barnes, 1999; Industrial Restructuring Project: Policy Brief no 5, 2000

- *Whom to benchmark against?* The analytical challenge is to document *relative* productive efficiency, but relative to whom? Here there are a number of options, comparing a firm or a chain against:
 - its own, historic performance
 - the performance of firms doing very similar things (for example, fresh fruit with vegetable packers); this close-comparison is especially useful, but may often be difficult to achieve
 - the performance of firms in the same sector, but not making the same products (for example, brake-hoses and filter-manufacturing in auto components)
 - performance of firms in other sectors, but with similar processes (for example, comparing quality processes in banking and insurance services)

In general, benchmarking is best undertaken with firms producing like-for-like products and services, but this may often not be possible.

- *What to benchmark?* Two sets of benchmarked data are important:
 - Which activities to benchmark? In general, benchmarking has been applied to activities involving the physical transformation of inputs, for example operations on the shop-floor in industry, growing practices on the farm in agriculture, and down the mine in the resource sector. But in many cases, and increasingly (as we have seen in previous sections of this Handbook), these transforming activities may not be critical to chain effectiveness, and may also represent only a small fraction of total final costs. Therefore, where relevant and possible, it will also be desirable to benchmark comparative processes in design, marketing and office activities (such as order-processing).
 - A distinction should be drawn between practices and performance. For example, quality circles and continuous improvement schemes are *practices*, which can be readily compared between firms (number, content and duration of meetings), whereas the percentage of scrap in production, the products returned by consumers, and number of suggestions recorded are *performance* outcomes (see Figure 20 above).

A major problem here is that many firms do not collect the relevant data, or may collect data but not centralise the information which has been recorded. In these circumstances, the researcher may have to visit the relevant middle managers and assemble the relevant firm-level data.

- *How to organise benchmarking?* Depending on the depth of analysis, the best way to benchmark is to visit each of the comparative firms/farms, and to collect a mix of quantitative and qualitative data. But this may not be possible, so recourse may need to be made to questionnaires. Getting access to firms is often not easy. One way to do this is to offer like-for-like confidential benchmarks. In these cases each firm is only told that the comparator firm is in “another merging economy”, or “Europe” or any other place which best describes the locational position in an anonymous form. Sometimes offering a “free and confidential benchmark” (which will be very costly if the firm has to purchase this data on the open market) is an inducement to cooperate. But in other cases, and particularly in Europe, benchmarking has been oversold, and firms are often reluctant to cooperate under this heading. Moreover, firms which are linked to affiliates in TNCs may already participate in internal benchmarking activities, and may see this as being in conflict with the proposed benchmarking, or as being unnecessary. In these circumstances, approaching the firm as independent researchers, without mentioning the phrase benchmarking, may be the most effective point of entry.

13 GOVERNANCE OF VALUE CHAINS

Before opening-up the concept of governance, it is necessary to begin with two general points:

1. The power which any party may have in the chain may paradoxically be reflected in two seemingly contradictory attributes. The first is obvious and arises from the power to force other parties to take particular actions, for example to limit themselves to assembly rather than to involve themselves in design. But, secondly, it may also reflect the capacity to be deaf to the demands of others, that is to refuse the demand to confine activities to assembly alone.¹⁶ These contradictory effects also arise from the fact that parties are often involved in different value chains and these may result in cross-cutting power between value chains with the demands of one dominating the other with detrimental effects down the chain. An example of this is in timber in South Africa where two distinct value chains emanate –pulp and paper on the one hand and furniture on the other. The major corporation involved in growing and sawmilling is dominated by its producer-driven pulp and paper interests and hence is unresponsive to, often blocks the operations of, and is deaf to the requirements of downstream firms in the buyer-driven furniture value chain.

2. The extent of chain power may be related in complicated ways to the relative size of a particular firm in the chain. In general, the larger the firm, the more influential its role. But “large” in relation to what? Here there are a number of possibilities, of which the most important (Figure 21) are the:
 - share of chain sales
 - share of chain value added
 - share of chain profits
 - relative rate of profit
 - share of chain buying power
 - control over a key technology and distinctive competence
 - holder of chain “market identity” (e.g. brandname)

Which of these indicators is important will be contingent on the characteristics of a particular chain and the question being pursued. But it will also be important to distinguish the territory of enquiry, that is whether the relevant size is indicated by the firm’s share of global, national or local activities.

¹⁶ We are grateful to John Humphrey for making this point to us.

Figure 21: How to identify the key governor in the chain

Indicators	Strengths and weaknesses	Source of data
Share of chain sales	Not a strong indicator as may only be a reseller of bought-in materials and may lack influence	Balance sheets
Share of chain value added	A better indicator for measuring size since it reflects the share of the chain's activities	Firm-level interviews
Share of chain profits	May be a good reflection of chain power, but may also arise from monopoly control over scarce raw materials (e.g. platinum) and may have little influence over downstream processing	Balance sheets, but it is likely that this data will only be available for publically-owned companies
Rate of profit	A poor indicator since minor players in the chain may be relatively profitable but have little influence	Balance sheets, but it is likely that this data will only be available for publically-owned companies
Share of chain buying power	A good indicator of power, particularly if there are asymmetries, that is its dependence on its suppliers is less than their dependence on the lead firm	Firm-level interviews
Control over a key technology (e.g. drive- train in autos) and holder of distinctive competence	A good indicator in producer-driven chains such as autos since this defines the distinctive competence of a chain (BMW's image as a quality, refined car) while the smaller firms 'fill in the gaps' in the chain.	Firm level interviews
Holder of chain "market identity" (e.g. brandname)	May be critical in markets where brand image is very important	Firm-level interviews; studies of market share of brands in final markets

13.1 "Governance": An overview

We have seen in earlier parts of this Handbook that one of the distinctive features of value chain analysis is its focus on governance, highlighting both power relations in the chain and the institutions which mould and wield this power. We also argued that this function of governance was best understood through the lens of civic governance, with its analysis of:

- Different functions associated with the "regime of rule-making and rule-keeping" – that is, making the rules ("legislative governance"), implementing the rules ("executive governance") and enforcing the rules ("judicial governance")
- The positive and negative sanctions which are used to enforce these rules
- The legitimacy of the power of the rule-makers
- The extent of governance of the rule-makers, that is, its reach. Associated with this is the issue of boundaries, that is whether the rules are a product of relations

between different parties in the chain, or whether external parties are also involved.

Since these issues of governance are both central to, and relatively distinctive to value chain analysis, the methodological issues are particularly important to resolve. Let us take each in turn:

13.2 Rule-making and rule keeping

Figure 22, repeated from Part 2 above, sets the framework for data collection. It distinguishes the three realms of rule-making, rule-monitoring and assisting producers to achieve the necessary rules, and also identifies operating environments in which these functions may be performed by parties internal to the chain, or outside of the commercial operations of the chain. But how are these to be researched?

Figure 22: Examples of legislative, judicial and executive value chain governance

	Exercised by parties internal to chain	Exercised by parties external to chain
Legislative governance	Setting standards for suppliers in relation to on-time deliveries, frequency of deliveries and quality	Environmental standards Child labour standards
Judicial governance	Monitoring the performance of suppliers in meeting these standards	Monitoring of labour standards by NGOs Specialised firms monitoring conformance to ISO standards
Executive governance	Supply chain management assisting suppliers to meet these standards Producer clusters/clubs assisting members to meet these standards Representative agents assisting members to meet these standards	Specialised service providers Government industrial policy support Producer business associations assisting members to meet these standards

13.3 Types of rules

With regard to legislative governance, there are two sets of factors which can be used to categorise different types of rules. The first is the extent to which they are codified. The standards may be set in legal codes, and subject to fines if transgressed. They may also be internationally recognised, and widely used, even though they have no legal basis. This recognition may be less than global, but cover a number of product markets, or they may be firm specific. The second axis is whether the rules cover products or processes. Figure 23 provides some examples of these different forms of rules and standards, but it is important to note that:

- Some rules cross industries (e.g. ISO9000 and ISO14000), whilst others are industry specific (HACCP in the food sector)
- Different rules will often be exercised within the same chain. In some cases, particularly when the rules-regime is subject to pressure from civil society, the number of rules to which producers have to respond can be overwhelming. (One Chinese firm reported being audited by teams from 40 customers in a single

month, from a combination of buying firms, external audit firms, and NGOs!)¹⁷, and this is one of the factors which explains why private sector parties often actively search for public recognition of process and product rules.

Figure 23: Two sets of factors determining the rules-regime, and some examples

Type of standard	<i>Product</i>	Food hygiene standards; lead content in toys	G3 standards for cellular phones	“Homogolisation” of regulations on product types (eg for automobiles in the EU)	Firm standards supporting brand name
	<i>Process</i>	Health and safety standards in work	ISO9000 (quality) SA8000 (labour)	QS9000 (quality in autos, originating in the US), BS5750 (quality standards originating in the UK)	VDA6.1 (VW quality standard)
	<i>Legal codification</i>		<i>Internationally agreed</i>	<i>Regionally specific</i>	<i>Firm specific</i>
Type of codification					

13.4 Internal and external rule-setting

Increasingly, rules which pertain in the final market, are being set by supranational bodies such as the European Union. These externally-set legal rules generally transcend all others in importance, and can be identified by examining these legal codes. But there may also be a rule-setting process which has no legal backing, for example pressure from NGOs for value chains to achieve environmental standards (e.g. Forestry Sustainability Council, FSC, accreditation in wood and furniture), or to exclude child-labour. A primary source of data is of course the relevant statute book, but in general these will be impenetrable and time-consuming. Since this is the business of the link in the chain selling to the final customer, an obvious point of entry is the sales function in the final link in the chain. Where relevant, interviews with, or searches of the web-sites of NGOs (which are generally informative) will also be helpful.

Less obvious are those rules which govern a chain and which are informal, that is, they have no official, legislative backing. For example, key parties in the chain may require conformance to certain quality-processes (such as ISO9000, or QS9000 in the auto sector, and HACCP in the food sector). These data can generally best be obtained from the purchasing departments of each of the major chain-members. But there may also be an issue of miscommunication between buyers and sellers (as we saw in the discussion above on CSFs), or commitment to these rules may be thin, so it may also be helpful to interview the people responsible for sales in the firms feeding into these primary links in the chain.

¹⁷

Data provided by Mil Niepold of Verite.

Figure 24: Analysis of rule-making regime

	What to look for	Types of data	Sources of data
External to the chain	Legislative requirements – e.g. quality standards.	Regulations (e.g. on shelf-life; safety standards)	Interviews with sales function in final link in the chain (e.g. supermarkets); statute books (usually available on the www).
	Informal rules promoted by civic associations	Data on processes in production (e.g. with regard to safety, environment, or labour standards)	Interviews with sales function in final link in the chain; discussions with NGOs (or search of their web-sites)
Internal to the chain	Rules set by key links in the chain which producers need to attain	Quality standards (e.g. parts-per-million defects); environmental standards; % on-time-delivery	Interviews with major buyers and with sales function in producers feeding into these buyers

Rule-monitoring is an important component of the research, since it provides a window into the “reach and rich” of the rules-regime. In most chains, the auditing process will be done by a mix of parties, both internal to and external to the chain. For example, in the wood and furniture chain, FSC accreditation of producers is undertaken by firms such as SGS, who have over the years have come to specialise in different forms of auditing. (Previously, during the 1970s, 1980s and early 1990s, a primary source of revenue for SGS was the auditing of exports and imports for governments in order to inhibit false-auditing and transfer pricing). Similarly, ISO9000 standards are monitored, with annual inspections, by firms which undertake this service on behalf of the ISO organisation headquartered in Geneva. On the other hand, many of the rules set by key links in the chain for the suppliers are monitored by the buying firm itself, for example the performance of suppliers with respect to on-time-deliveries and parts-per-million (ppm) quality standards.

Figure 25: Monitoring the rules-regime

	What to look for	Monitoring agents	Sources of data
External to the chain	Legislative requirements – e.g. quality standards.	Government or regional standards offices	Standards officers; interviews with final link in the chain
	Informal rules promoted by civic associations	NGOs; press	Interviews with final link in the chain; discussions with NGOs (or search of their web-sites); search of press (www sites widely available)
Internal to the chain	Conformance to rules set by key links in the chain which producers need to attain	Key buying firms in the chain	Purchasing function in these key buying firms

Whatever the reach of the rules-regime, and the monitoring capability which is available, one of the most important issues to be addressed in the research on value

chains and governance is the extent to which producers in the chain are helped to achieve these rules. Evidence from across the world shows that market forces alone are sub-optimal in achieving these ends, and a key function of governance is to compensate for this market failure and to ensure that suppliers develop the capability to comply as rapidly as possible. Many text books suggest that the assistance provided to producers comes from the dominant rules setters – for example, it is widely believed that Toyota directly helps to upgrade its suppliers, that Marks and Spencer historically did the same for its suppliers in the UK, and that the GAP performs the same function in the global clothing industry. In reality, however, this is seldom the case, and there are generally a number of parties who act as intermediaries and help suppliers to meet the chain-rules. The major parties involved here are:

- First-tier suppliers. These are key suppliers in the chain, who command major technologies or have power as a result of their scale, and who assist their own suppliers in meeting the rules set by the chain governor(s)
- Buying agents of lead firms located outside the home country who not only broker contracts but also assist supplier firms in meeting the standards required.
- Specialised consulting firms often play an important role, sometimes assisted by Government support. For example, during the second half of the 1980s, new quality and logistics procedures inside UK manufacturing supply chains were diffused through a growing number of consultants partially funded by the government's "Inside UK Enterprise" programme. In other cases, these consulting firms spun-off from established manufacturing firms. A case in point here is the group responsible for the introduction of just-in-time in Lucas industries in the UK during the 1980s, which began by selling its services to other manufacturing firms, and then to the public sector (for example, hospitals), and was subsequently taken over by CSC of the USA. During the same period, many accounting firms also began to see the potential market for services facilitating suppliers to meet new standards set by their buyers. For example, Price Waterhouse Coopers licensed the use of the Kawasaki Production System, and sold these capabilities to firms in Zimbabwe (Kaplinsky, 1994) and India.
- Often, particularly when value chains involve small firms, learning networks develop to assist producers in meeting chain-rules. In some cases these networks are outcomes of Business Associations, or local government initiatives (as in the case of Germany, Semlinger, 1995) or national programmes (as in the case of Denmark, Martinussen, 1995, or South Africa, Morris 2001, Barnes and Morris 1999)
- Government agents can also directly perform the role of assisting firms to achieve chain rules. For example, during the second half of the 1990s, the UK government established the Business Links programme which provided services to firms, generally SMEs, in making the necessary internal changes.

Figure 26: Assisting firms to meet chain-rules

	Change agents	Sources of data
External to the chain	Consulting firms	Interviews with consultants; CEO or production control in firms
	Learning networks	CEO or production control in firms; Business Associations
	Government agents	CEO or production control in firms; interviews with government officers (local and national) responsible for industrial policy
Internal to the chain	Rule-setting firm	Supply chain management or purchasing function in purchasing firms; CEO or production control in supplying firms
	Buying agent of rule setting firm	Interviews with agent and CEO of recipient firms; supply chain management operations
	1 st -tier or other leading suppliers to rule-setting firm	Supply chain management or purchasing function in purchasing firms; CEO or production control in supplying firms

13.5 Sanctions in the rule-regime

Rules may be set, but not kept. In these cases the incentive system may be weak, lacking any bite in the positive or negative sanctions which might encourage changed behaviour. Without effective sanctions, chain governance may have little meaning, so this is an important area of study. It is necessary, here, to focus both on negative and positive sanctions. From within the chain, the key sanction is delisting, that is excluding a supplying firm from participating in the chain. But there may be milder forms of sanctions such as consigning the supplier to a “swing” status, that is a backup position in case of supply shortfalls, or ensuring that all incoming deliveries from that supplier are checked and the cost passed on to the supplier through lower purchase prices. The converse of this, of course, is that well-performing suppliers can be favoured with longer-term contracts, lead-supplier status and higher prices.

Sanctions may also be exercised outside of the chain, and most governments have extensive bureaucracies checking compliance to legislation and prosecuting offenders. In recent years, NGOs have grown into an important sanctioning force, particularly in the final consumer goods sectors. Boycotts and publicity campaigns have forced many leading firms to change the way they produce, or to delist particular suppliers. Less powerful have been the attempts to reward conformance through positive buying campaigns, for example rewarding companies for compliance to new norms of social and environmental behaviour. Voluntary associations of informal economy producers/traders in some countries are also playing a positive role in formalising the link of informal economy producers within a value chain, and defending members against local manipulation by coordinating/managing agents through getting larger firms to set transparent rules/remuneration agreements. For example the Self Employed Women’s Union in South Africa has formalised the relationship between informal cardboard recyclers, the local pick up agents and the large paper producers.

Figure 27: Sanctions and rule keeping

	Types of rule	Positive sanctions	Negative sanctions	Data sources
External to the chain	Legislative requirements – e.g. quality standards.	None	Fines; compulsory closure	CEO and finance function in supplying firm; press
	Informal rules promoted by civic associations	Promotion of brand	Consumer boycotts; adverse publicity; campaigns	CEO and sales function in key firms; interviews with NGOs; press
Internal to the chain	Rules set by key links in the chain which producers need to attain	Lead-supply arrangements; long-term relationships	Delisting as a supplier; swing-supplier status; lower prices due to checking of all incoming materials	Purchasing function in buying firm; sales function in supplying firm

13.6 The legitimacy of power

The effectiveness of a governor's command of a chain does not only reflect the power of its sanctions, but also the trust which its suppliers or customers have in it. This is particularly important in assessing the long-term viability of the chain. There is of course an extensive literature on trust, much of it theoretical in nature (Humphrey and Schmitz, 1996). But it is possible to identify a number of data points which will help in assessing whether the links in the chain are imbedded in a high-trust or a low-trust environment. Each of these low- and high-trust categories will tend to see a clustering of the following types of behaviour in relation to:

- ❑ the length of contracts
- ❑ the nature the ordering procedure
- ❑ the nature of the contractual relationship
- ❑ the modes of inspection used in accepting incoming materials
- ❑ the degree of dependence which firms have on each other
- ❑ the types of technical assistance which flows along the chain
- ❑ the nature and methods of communication along the chain
- ❑ the determination of prices
- ❑ the nature of credit extended along the chain especially to exporting firms
- ❑ the modalities of payment to outsourced informal economy producers

Figure 28: Assessing trust relations in the value chain

	Low trust chains	High trust chains	Data sources
Length of trading relationship	Short-term	Long-term	Sales function in suppliers, purchasing function in buyers
Ordering procedure	Open bidding for orders, with prices negotiated and agreed before order commissioned	Bidding may not take place, or likely winner known in advance. Prices settled after contract awarded	Sales function in suppliers, purchasing function in buyers
Contractual relationship	Supplier only starts production on receipt of written order.	Supplier more flexible about instructions and will start production without written order.	Sales function in suppliers, purchasing function in buyers
Inspection	Inspection on delivery.	Little or no inspection on delivery for most parts.	Sales function in suppliers, purchasing function in buyers
Degree of dependence	Supplier has many customers, and customer has multiple sources.	Few customers for supplier and single- or dual-sourcing by customer.	Sales function in suppliers, purchasing function in buyers
Technical assistance	Expertise rarely pooled, and assistance only when paid for.	Extensive unilateral or bilateral technology transfer over time.	Production control, quality and product development functions in both supplying and purchasing firms
Communication	Infrequent and through formal channels. Narrowly focused on purchasing department.	Multi-channelled, including, engineers, personnel department and top management; frequent and often informal.	Production control, quality and product development functions in both supplying and purchasing firms
Price determination	Adversarial, with hiding of information.	Non-adversarial with "open books".	Sales function in suppliers, purchasing function in buyers
Credit extended	Punitive or no credit extended	Easy access to letters of credit, longer payback period, easy terms.	Nature of letters of credit, finance section in suppliers and buyers
Outsourcing payment terms	Long delays in paying agents and informal economy producers	Payment on receipt of finished goods	Outsourcing agents, outsourcing firms, informal economy producers

Source: Adapted from Humphrey, Kaplinsky and Saraph (1998)

13.7 The pervasiveness of the rule-regime

A final component of value chain governance is the extent to which the rules of incorporation pervade chain relationships. Although it is difficult to separate this concern from the “richness” of these rules – that is, how in reality they actually affect firm behaviour (which is a function of sanctions and legitimacy in the chain) – it is an important issue. It also relates to the fact that, as we shall see below, in many cases chains may have more than one rule-setting lead-firm, so the issue is one of whose rules-agenda is heard most loudly.

Apart from the obvious method of conducting qualitative interviews along the value chain, a practical and useful way to research this issue is to utilise the methodology employed in the analysis of CSFs. The object of this exercise is to determine how far

along the chain the rule-setter's domain exists. Two exercises can be undertaken here, in each case utilising the 1-7 scale and radar charts discussed above. The method mapped out in Figure 29 are based on the lead-firm being at the top of the chain, and then working backwards. But lead-firms may also be in the middle or at the bottom of the chain, in which the same exercise needs to be carried up the chain as well as down the chain.

Figure 29: The pervasiveness of the rules-regime^a

The issue	Method	Respondents
Is the lead-firm's rules agenda heard throughout the chain?	<ol style="list-style-type: none"> 1. Identify lead firm 2. Identify its key requirements as a buyer and rank these (1-7 scale) 3. Ask sales functions in various tiers of the chain to rank the importance of these same key requirements on the 1-7 scale 4. Compare rankings 	<p>Buying function in lead firm</p> <p>Sales function amongst all supplying tiers in the chain</p>
How many lead-firm's rules are heard?	<ol style="list-style-type: none"> 1. Ask sales functions in various tiers of the chain to identify key rules of participation (i.e. "what standards do you have to achieve in order to make yourself a lead supplier/ customer"?) on a 1-7 scale 2. Perform this exercise for each chain the supplier feeds into 3. Compare requirements of suppliers and rankings 	<p>Buying function in lead firm</p> <p>Sales function amongst all supplying tiers in the chain</p>

^a This figure is premised on lead-firm being at the top of the chain: adjustment will be required when lead firm is in the middle or near the bottom of the chain, to incorporate links up as well as down the chain

14 UPGRADING IN VALUE CHAINS

The process of upgrading in the value chain cannot be easily separated from those of rent, barriers to entry and distribution which are covered in the next section of this methodological discussion. This is because, by definition as we have seen, upgrading has a comparative component, and in this sense it is distinctive from innovation. However, for the moment, in this discussion of methodology we will treat upgrading in isolation from the experience of other firms in the chain, and other chains.

In pursuing this discussion, we draw on the four forms of upgrading discussed in Part II above. As we saw, by spanning the relationship between firms, as well as identifying the issue of functional upgrading, value chain analysis takes the discussion of upgrading beyond the standard perspectives of core competence and dynamic capabilities. The four forms of upgrading are with regard to:

- Improvements in process, either within a firm, or as a result of a series of linked actions in the relationships between firms
- Improvements in product, either within a firm, or as a result of a series of linked actions in the relationships between firms
- Changing functional positions, by adjusting activities undertaken within a particular link, or moving to activities taking place in other links
- Moving out of the value chain, into a new value chain

How are these different forms of upgrading to be researched? In undertaking this research it is important to keep the distinction made in the discussion of benchmarking in mind, that is the necessity to analyse and record both upgrading *practices* and the *performance* outcomes of these practices. Figure 30 suggests a set of practices and the corresponding performance outcomes which can be documented. (Most of these performance indicators are well-recognised and easily understood. The exception is the issue of increased relative unit product prices and its link to market share – for an elaboration of this, see Kaplinsky and Readman, 2000).

**Figure 30: Examples of Indicators of Innovation and Upgrading:
Practice and Performance**

Type of upgrading	Practices	Performances
Improving process efficiency		
Within the chain link	R&D; changes in logistics and quality practices; introducing new machinery	Lower costs; enhanced quality and delivery performance; shorter time-to-market; improved profitability; enhanced patenting activity
Between chain links	R&D; supply chain management procedures; e-business capabilities; facilitating supply chain learning	Lower final product costs; enhanced final product quality and shorter time-to-market; improved profitability throughout value chain; enhanced patenting activity
Introducing new products or improving existing products		
Within the chain link	Expansion of design and marketing departments; establishment or strengthening of new product development cross functional teams;	Percentage of sales coming from new products (e.g. products introduced in past year, past 2 and past 3 years) Percentage of sales coming from branded goods
Between chain links	Cooperating with suppliers and customers in new product development – concurrent engineering	Number of copyrighted brands Increase in relative unit product prices without sacrificing market share
Changing the mix of activities		
Within the chain link	New higher value added chain-specific functions absorbed from other links in the chain and/or low value added activities outsourced	Division of labour in the chain Key functions undertaken in individual links in the chain
Between chain links	Moving into new links in the chain and/or vacating existing links	Higher profitability; increase in skill and salary profile
Moving to a new value chain	Vacating production in a chain and moving to a new chain; adding activities in a new value chain	Higher profitability; proportion of sales coming from new and different product areas

Reflecting the efforts taken to upgrade production, and measuring the performance outcomes of these efforts is only one part of the upgrading story. It is also important to determine agency, that is to identify those parties who are responsible for upgrading these activities. Here the discussion links to the issues discussed in the previous section on governance, since upgrading not only reflects the capacity to meet the rules of chain-incorporation, but also to be proactive in setting them. At one level, this proactivity may be reflected in the capacity to determine the rules which others are obliged to follow (i.e. chain leadership). However, competitive capabilities may

be another way of changing the rules-agenda by encompassing new order-winning capabilities, that is the capability to perform at standards which lead chain-governors to set more demanding rules for competitors to follow (see the earlier discussion of order-winning capabilities). Here, a particular link in the chain may achieve performance levels (for example, better quality at reduced costs) or introduce a new technological capability through introducing inter-firm ICTs which effectively exclude competitors from the chain. Alternatively, this ability to achieve upgraded process performance levels may result in it being able to leapfrog up a chain, through winning higher performance demanding contracts normally assigned to another firm, thereby excluding the latter from the chain. It is also important to bear in mind that one of the indicators of power in the value chain reflects the capacity of individual firms to be deaf to the rule-setting agenda of others, that is to over-ride constraints and pressures on their upgrading activities.

It is helpful here to also distinguish between factors which both block and which enable upgrading activities. This analysis cannot be effectively pursued without also forming a judgement on the areas of rent in the chain, and the barriers which exist to new entrants, both of which are discussed in the following section. However, it is important to focus on those blockers and enablers which are endogenous to the firm, and those which are a result of the actions of others. Figure 31 gives some examples of these blockers and enablers, but it is difficult to produce structured templates for examining these phenomena which are essentially contingent in nature.

Figure 31: Examples of blockers and enablers to upgrading

	Blockers	Enablers
Inside the firm	<ul style="list-style-type: none"> • Resistance from middle management to new work practices; • failure of senior management to commit resources to new product development; • lack of adequate skills 	<ul style="list-style-type: none"> • CEO committed to upgrading; • effective R&D management; • structured processes for continuous improvement
Outside the firm	<ul style="list-style-type: none"> • Buyers who block suppliers from using own designs • Intellectual property rights • Lack of skills in the economy • Poor IT infrastructure 	<ul style="list-style-type: none"> • Chain governor which promotes and assists upgrading by chain members • Well established and proactive business service providers allied to facilitative government programmes • New legislation forces firms to upgrade • Rising prices for inputs and/or increased competition

14.1 DISTRIBUTIONAL ISSUES

One of the distinctive features of value chain research in development studies is its concern with distributional issues. In this sense, the discussion, the research domain

and the methodology utilised differs to a considerable extent from those used in value chain analysis in business studies, where the focus is on competitiveness alone. This is not to deny any overlap between the two discourses, but rather to highlight the fact that development studies concerns are distinctive and much wider than those in other disciplines, both because of its social agenda and also (albeit to a lesser extent) because of its inter-disciplinary focus.

Distribution has both power and income components. The former concerns the balance of leverage which different parties have in determining the distribution of who does what in the chain and the returns which accrue to different parties. Since earlier discussions on governance and upgrading have focused on institutional issues and governance, in the discussion which follows, we will largely concern ourselves with the distribution of income. In pursuing this distributional research agenda, it is necessary to work through the following components of value chain analysis:

- what are the different forms of rents and barriers to entry which are the underlying determinants of the distribution of the returns from global production chains?
- the unit of account, that is which currency is utilised to measure income
- in what circumstances value added and turnover data illuminate the analysis?
- how is profitability to be measured, and are profits an appropriate measure of distributional outcomes?
- the locational dimensions of global value chain distribution - global, national and local
- decomposing income streams - class, income groups, gender and ethnicity
- how a knowledge focus can be incorporated into the analysis, opening up the distribution between skills
- how do SMEs fit into global value chains

14.2 Rents and barriers to entry

In Part 2 above, we outlined the theory of rent, in which we argued that sustainable income growth requires the capacity to protect oneself from competition, that is to take advantage of, or construct barriers to entry. We also identified a number of types of rent, those which were based on firm level actions (technology, training, better organisation and marketing), those which were based on chain level actions (better links between firms), those which were based on resources (access to high-quality raw materials), and those which were provided by parties external to the chain (effective government policy, infrastructure, financial intermediation).

In pursuing this analysis it is important to bear in mind that rent only has meaning in a comparative sense – having access to capabilities which others do not possess – and hence that the methodology and analysis needs to reflect scarcity and barriers to entry. Moreover, in most cases, rents are dynamic, as few barriers to entry are absolute.

Finally, the points discussed below and in Figure 32 are only illustrative; this is a rich research tapestry, often involving specialised and in-depth enquiry.

- ❑ With regard to *technological rents*, it is customary to use both input data (% of sales on R&D) and output data (patents registered); neither are perfect indicators, but together they do tell a story. Both sets require a combination of firm-level enquiry and access to public data sources, of which the US Patent Office (a particularly rich data source on patents), and national census data and the OECD (for data on R&D)
- ❑ *Human resource capabilities* are generally reflected in training, but also involve work-practices. Comparative data sets are not strong (although the ILO and UNESCO Yearbooks do provide some), so firm-level analysis is the most important data source here.
- ❑ *Organisational skills* in the firm, predominantly nowadays associated with lean production, are reflected in performance with regard to inventories, quality, new product development and lead time. Similarly, relational rents in the chain are also reflected in these performance indicators, but at the chain level rather than the firm level. These data are best collected at the firm-level, since published data and data available in consultancy reports tend to be too general.
- ❑ *Marketing rents* are most visibly reflected in brand-name presence, which in turn is largely fuelled by advertising; however, intermediate products in particular tend not to be associated with distinct brand-names, but may nevertheless require marketing. Hence firm-level records on marketing expenditures are an important data source.
- ❑ *Resource rents* arise from high-yielding mineral deposits and land, and data on this is available both at the firm-/farm-level and in sectoral studies produced by international agencies and consulting firms. Firm-level enquiry is obviously also an important data source.
- ❑ *Policy rents* reflect both the design of policy and the effectiveness of implementation, and are best researched at the firm-level
- ❑ *Infrastructural rents* reflect the relative effectiveness of communications, particularly in the 21st century, with regard to telecommunications and the internet. The International Telecommunications Office (ITO) and the World Bank provide good data sources on country-level capabilities, but firm-level analysis is also important
- ❑ *Financial rents* reflect a combination of low levels of bureaucracy, low interest rates, access to venture capital and regulations on security. This data is best obtained at the firm-level.

Figure 32: Examples of indicators of rent and relevant data sources

Type of rent	Indicators of rent and barriers to entry	Data sources
Rents constructed by the firm		
Technology	Investments in R&D	Firm records; Financial Times and Business Week (www sites available); OECD for national data
	Patent statistics	www.uspto.gov/web/menu/search.html
Human resources	Skill profile, training	Firm records; ILO and UNESCO Yearbooks
Organisation	Continuous improvement schemes, inventory and quality performance, lead-time	Firm records; published materials and consultancy reports
Marketing	Advertising expenditure, brand performance	Firm records; www.advertisingadage.com
Rents constructed by the chain		
Relational rents	Continuous improvement schemes, inventory and quality performance, lead-time for the chain	Firm records, particularly for firm at apex of the chain
Resource rents		
	Yield of mining deposits and land	Firm records; UNIDO, FAO and World Bank industry studies; firm records
Rents accruing from actions external to the chain		
Policy rents	Effectiveness of government support; incentives	Comparative firm analysis and policy-analysis
Infrastructural rents	Telecoms and roads	ITO, World Bank studies
Financial rents	Interest rates; policies on security	Comparative firm analysis

14.3 The unit of account, that is which currency is utilised to measure income

Global value chains describe and analyse the incorporation of producers in global product markets; they also generally involve global factor markets, since it is not only goods and services which flow between countries, but also human skills, finance and technology. This leads to major problems in comparing the costs of factors, and the returns to resources invested in production. There are a number of difficulties which arise here. One is that inflation rates differ around the world, and that currency rates do not always catch up easily or quickly with this variation. A second problem is that currency exchange rates are increasingly affected by speculative flows of capital. For example, during the 1999-2001 period, it was widely accepted that the euro was

significantly undervalued in relation to the dollar, and in 1997-9 East Asian currencies were severely undervalued after the regional crisis. And, thirdly, a dollar in one country seldom buys what it can in another, and in some cases this disparity can be very significant.

There are basically two ways into providing units of account which allow for accurate measures of cross-country costs and incomes:

- the real exchange rate
- the purchasing power parity adjusted exchange rate

The real exchange rate makes it possible to take account of changes in the exchange rate between countries arising from differential rates of inflation and is particularly helpful in comparing changing cost profiles over time. In essence it is calculated by the ratio:

$$\frac{\text{the nominal exchange rate multiplied by an index of world prices}}{\text{an index of domestic prices}}$$

The problem with the real exchange rate lies in the computation of the price indexes. From the domestic point of view, there are a number of indicators available (for example in the IMF Yearbook), but it is probably best to utilise either the GDP deflator (an indicator of the general price level) or the wholesale price or producer price index (an indicator of production prices). These exist for most countries. The bigger problem lies with what is used to measure the “world price”. Often the US GDP deflator is used, but this only makes sense if the exporting country has all of its trade with the USA, which is never the case. Therefore, to be useful, the real exchange rate has to be weighted by using the price indexes of all the major trading parties (both for imports and exports) in proportion to their share of exports and imports. In practice, therefore, although there are clear methodologies for using the real exchange rate, in practice it is too time-consuming for most value chain analyses and it is therefore better to use purchasing power parity prices as a way of correcting for the inaccuracy of the nominal exchange rate.

Figure 33: Caveats and data sources for real exchange rate calculation

	Caveats	Source of data
Nominal exchange rate	Be consistent and use either mid-year or end-year figure	IMF Yearbook
Domestic price index	Depends on what is available; where there is a choice, use GDP deflator or producer or wholesale price index	IMF Yearbook, World Bank World Development Indicators, each country’s national accounts statistics
“World price” index	Do not use US price index, but weighted price index	IMF Yearbook, World Bank World Development Indicators, each country’s national accounts statistics Trade statistics from each country’s trade data or from UN COMTRADE data-base

Purchasing power parity (PPP) exchange rates are designed to reflect real purchasing power of currencies. They are not only easier to use than real exchange rates, but also relate more directly to the consumption power of incomes, and since the focus on analysis in this section is on distributional outcomes to global production networks, they are the more appropriate measure to use. The index is computed by comparing the costs of acquiring the same basket of goods in different countries. Table 5 shows the disparities and misunderstandings which can arise when comparing data at current exchange rates and those which take account of the purchasing power of currencies. For these countries, the two most extreme cases are India (where per capita incomes at market prices barely changed between 1990 and 1997, although real PPP incomes increased by more than 50%), and Japan (where incomes at market prices increased by 45%, whereas those at PPP rates increased by only 30%). Studies of inter-country income distribution should ideally use the PPP rates, which are easily obtained from the World Bank Indicators dataset or from

<http://cansim.epas.utoronto.ca:5680/pwt>

These PPP rates can be compared as a ratio to the official exchange rates and used to “normalise” all the measured values into some form of globally comparable figure. PPP rates are also not without their problems, notably the choice of the basket of goods which are used in comparing prices, but all things considered, it is probably a better measure for value chain analysis than are real exchange rates, not least because of their ease of measurement. But no measure is perfect, and the analysis will need to take account of these imperfections in the interpretation of the data.

Table 5: Divergence between GNP/capita at market and PPP rates, current dollars

	1990	1997
Bangladesh		
Market prices	280	360
PPP prices	750	1,090
Brazil		
Market prices	2,670	4,790
PPP prices	4,880	6,350
China		
Market prices	420	860
PPP prices	1,390	3,070
India		
Market prices	350	370
PPP prices	1,100	1,660
France		
Market prices	19,750	26,300
PPP prices	17,810	22,210
Japan		
Market prices	26,400	38,160
PPP prices	18,830	24,400

World Bank (1999), World Development Indicators

14.4 In what circumstances turnover and value added data illuminate the analysis

A first step in value chain analysis, as we saw in the above discussion on mapping the value chain, is to build a tree of gross output prices, beginning at raw material source and ending with final products sold to the consumer. This is a fairly simple task, but it has only limited value in helping to analyse distributional patterns. In analysing distribution, it is more important to obtain data on the value which is added at each stage in the production of a good or service. This added value can take place:

- within discrete parts of a plant or firm or farm's productive activities
- within a particular plant, firm or farm
- within a link in the value chain (for example, in design, or marketing or production, which will not always be synonymous with the activities of individual firms in each of these links)
- in the sub-national locality and at the national level.

Before discussing the methods and sources which can be used to obtain this data, it is important to bear in mind one of the central lessons of lean production principles (Bessant 1991), which is that there is a distinction between costs and value in production. Costs are easily understood and measured; value is more complex and relates to the value of a product to the final customer. With "perfectly efficient" production systems, the two concepts may give the same answer. But as soon as there is any waste in the system – and this waste may arise from intangibles such as working capital costs required to finance chains with high inventories, or excessive

scrap and rework – costs will not align closely with value. This concept of value is much more difficult to estimate than costs, so the temptation is almost always to conflate the two.

In assessing value added, the central principle is to take gross output costs – including material costs, depreciation costs of equipment, labour costs, utilities and profit – and then to subtract total input costs (bought-in materials, components and services). This procedure should be applied at all levels of analysis, informed by the following level-of-analysis specific issues:

- Analysing the accretion of value *within individual parts of the firm or farm* is often not a simple task, particularly in large and diversified enterprises. This is because traditionally, costs have been calculated on a functional basis across all products – for example, wage-costs, fixed-investment costs, utilities’ costs – whereas the research objective may be to trace the cost profile of a particular component or product passing through a plant, firm or farm producing a diverse range of products. In recent years activity-based costing has been developed to enable the firm to more accurately assess the production costs of particular components or products (Johnson and Kaplan 1987) but few enterprises in developing countries may utilise this system. In these cases, the data will have to be assembled in discussion with the financial function in the enterprise.
- Calculating value added at the *plant, firm and farm level* is much easier. It is relatively simple matter to obtain total ex-plant/firm/farm costs, as well as purchases of materials and components. All of these datasets should be readily available from the finance function of the plant or enterprise.
- Data on value added *in particular links* in the chain is generally also not difficult to obtain. Prices collected at the end-point of each link can be used to calculate a rough picture of the accretion of value along the chain, as was the case for deciduous canned fruit exports from South Africa in Table 3 above.
- It is much more difficult to measure value added in a particular *sub-region* of a country, since few regional accounting systems exist. Generally, only rough approximations will be possible, perhaps based on analysis for key firms and/or through constructing a simple input-output mix for inputs. Federal political systems (e.g. India and Germany) tend to have much better regional databases than unitary political systems (e.g. Jamaica and Kenya).
- Only slightly less difficult is the calculation of value added at the *national level*. Here there may be two issues. The first arises when inputs and outputs are not traded, and this is a relatively simple problem since it is reflected in the final sales prices of the product. But only in very few cases are goods and services *and their inputs* wholly sourced domestically. Hence a second problem arises in trying to estimate the share of domestic inputs (and their inputs) in value added. In principle this is possible by subtracting imports from exports, but here problems arise because it may be difficult to identify all imported components and services, in production and (more importantly) because of 2nd and 3rd round effects. That is, “locally procured” goods may in fact have a high import content themselves, or their inputs may have a high import component. A subsidiary problem is that the

two systems available for recording output (the ISIC classification) and trade (the Harmonised System and the SITC classification) do not correspond closely; a country's output data will in general be difficult to reconcile with its trade statistics.

Figure 34: Different arenas of value added and sources of data

Value added in	What to look for	Data Sources
The activity within the plant/farm	Measure the role which discrete processes play	Use activity-based costing techniques in discussion with finance function of the firm
The plant/farm	Output costs (including profit) minus costs of material inputs and services; functional breakdown of costs (labour, depreciation, materials, utilities) also generally helpful	Finance function of the plant
The enterprise	Output costs (including profit) minus costs of material inputs and services; functional breakdown of costs (labour, depreciation, materials, utilities) also generally helpful	Finance function of the firm
The link in the chain	Differences between input and output costs for each link in the chain	Sales function in firm at apex of each link
The locality	Having defined the region, the difference between final output costs and materials and services imported into the region	Datasets are generally very poor, so rough approximations, simulating local input-output relationships (often involving primary research) will have to be made
The country	Contribution to GNP Net foreign exchange earnings	Value of final sales minus cost of inputs In a few cases where only domestic sourcing is involved, from value of exports. But in other cases, export values minus value of imports of relevant goods and services where these can be identified and repatriated profits

14.5 How is profitability to be measured, and are profits an appropriate measure of distributional outcomes?

A focus on the enterprise and on the role which constructed (“Schumpeterian”) rents play in determining the pattern of income distribution frequently throws the spotlight on profits, and this is often thought of as being a key to understanding the distributional outcomes of global production systems. For example, the National Farmers Union in Canada has undertaken an analysis of the agribusiness value chain, (Table 6). The primary aim of Farmers Union in assembling this data is to show that returns to farming (0.7% on equity over a five year period) are much lower than to those in other links of the chain (generally more than 17%).

But there are problems with this measure of profitability. A closer glance at the data in Table 6 shows that there is little link between the ratio of profit-to-sales and returns

on equity. For example, IBP (in beef and pork packing) and McDonalds (restaurants) have similar levels of sales and returns on equity, yet very different levels of profit absolute (C\$279m versus C\$2,279m respectively). This anomaly clearly arises because the equity base of IBP is significantly smaller than that of McDonalds. What this highlights is the problem of using “equity” in the denominator of the profitability calculation, since different firms (and indeed different national financial systems) will have different policies towards funding their investment needs. In some cases these are largely financed by equity, in other cases (for example in high-tech venture capital financed firms), most resources come in the forms of loans. Moreover, for old established firms, reinvested profits may be an important source of assets, and will not necessarily be reflected in the equity base.

Therefore, instead of using returns on equity, it is better to use returns on *net assets*. Net assets takes account of all the gross assets of a firm, which include equity, reinvested profits and outstanding payments due from debtors. It subtracts from this all the liabilities which the firm has, which includes short and long-term loans and money owed to creditors. But to what extent does the return on net assets take account of the returns to intangibles such as advertising, design and brand-names? Essentially these items are included in the cost stream as annual expenditures on these service activities. The returns to these activities are also included in the revenue stream in relation to the price premium earned on sales. Thus in terms of return on investments by the corporation, it is a helpful indicator of the returns to intangibles. But it is less helpful when considering the return to the equity-investor on the stock-market where equity prices are a reflection of long-lived reputation effects. For example, the brand names of Coca Cola reflected in its equity prices may correspond only loosely to the returns to corporate investment.

Another frequently used and less satisfactory indicator of “profit” is the mark-up on sales. It is sometimes argued that the higher this mark-up, the greater the “profitability” in any segment of the chain. However, this is a particularly flawed measure, since the “value” of a mark-up depends upon the volume of sales. For example, supermarkets may have low mark-ups, but may be very profitable given the size of their turnover. On the other hand, a producer of haute couture may have a small volume of sales, but the size of the mark-up may make it very profitable. In the abstract, therefore, the size of the mark-up in itself tells us little about the rate of profit of the enterprise.

Finally, if data is available (which is unlikely in most value chains) it may be possible to compute the total profit generated throughout the chain, and then apportion this to the different links in the chain, calculating their share of total profit. This provides a reflection of the share of profit accruing to different links in the chain rather than to their rates of profit. (The difference arises because of the different sums of investment required to generate profits in each link in the chain). But, depending on the specific distributional lens used in the analysis, if it is possible to compute profit shares, it may be helpful to adjust these for purchasing power, by correcting with the PPP values of these profits.

Table 6: Profitability in the Canadian agribusiness value chain

Link in value chain	Firm chosen ^a	Revenue (C\$m) (1998)	Profit (C\$m) (1998)	% return on equity (1998)	5-year % return on equity	
↓	Oil and gas	Imperial Oil	7,995	554	12.9	12.3
	Fertiliser	Agrium Inc	2,654	117	18.7	37.1
	Chemicals and seeds	Monsanto	12,718	368	-5.0	7.4
	Machinery	Deere	20,326	1,501	25.0	23.5
	Banking	Bank of Montreal	17,239	1,350	15.2	15.8
	Farming	276,548 farms	29,648	367	0.3	0.7
	Grain handling	United Grain Growers	1,887	16	8.7	3.9
	Railways	Canadian Pacific	10,247	801	10.3	7.0
	Food processing	Nestle	76,457	4,572	19.7	21.5
	Beef and pork packing	IBP	18,896	279	13.6	17.6
	Brewing and beverages	Coca Cola	27,666	5,195	42.0	51.9
	Cereal	Kellogg	9,944	739	53.0	41.6
	Restaurants	McDonalds	18,266	2,279	16.0	17.5

^a Original source provides data on a number of firms in each link of the chain

Source: Selected from Canadian National Farmers Union (2000).

Figure 36: Different profit indicators, strengths and weaknesses

Indicators of profit	Weaknesses and strengths	Data sources
Poor indicators of profit		
1. Return on equity	Ignores gearing through use of loans or payment schedules to debtors and creditors	Balance sheets
2. Margins on sales	Sales margins generally slimmest when value added is thinnest, but this may bear little relation to return on net assets	Interviews with finance function in firms; balance sheets
3. Share of total value chain profit	Enterprises typically feed into a number of value chains; takes no account of investments	Balance sheets and interviews with finance function in firm
Better indicator of profit		
Returns on net assets	Takes account of equity and loans and payment schedules to debtors and creditors	Balance sheets

However, even if appropriate measures of profitability are identified, how good a measure of value distribution will these be? The answer is of only a limited nature, because capital (whose reward is profit) is only one factor of production. In other words, the firm is not a good unit of account when looking at *income* distribution since it is factors (and not institutions) who are the recipients of income. Consider, for

example, the case where barriers to entry to new producers are low throughout the chain, as is the case in relatively perfect markets such as tea and coffee. Here, very few of the value chain participants make any profit, so little can be learnt about global income distribution patterns from an analysis of profitability.

Yet, at the same time, it is undeniable that the people working in the rich country supermarket chains and in the advertising agencies earn significantly higher incomes than those picking the tea in India and Kenya, even when account is taken of the PPP buying power of these incomes. The reason why this is the case is that there are barriers to the mobility of unskilled labour (through immigration controls) which ensures that supermarket workers in the rich countries do not have their wages bid down; and that there are skill barriers to entry in the advertising agencies which protect these salaries. The wages paid in these parts of the value chain reflect the general productivity of the economy at large, which determines the going rate for employment of the skills utilised in these two activities in the value chain, rather than the dynamics of the value chain itself. Yet, at the same time, since many rich country firms participate in the retail sector and in advertising, the rate of profit in these two sets of activities may be low.

For this reason, instead of using profits, or perhaps in addition to focusing on rates of profit on net assets or shareholders funds, it is perhaps more helpful to focus on the incomes which are sustained in different parts of the value chain (Figure 37). With regard to labour, this should take account of both formal and informal, full-time and part time, and permanent and occasional employment, as well as gender (and perhaps ethnicity) and should be calculated on an hourly basis (to reflect differences in the working day/week/year). In addition, since outsourcing has become an increasingly important phenomenon, it may also be necessary to undertake the same exercise amongst major suppliers and to average out the overall results across a number of links in the chain (depending on the focus of the particular value chain analysis).

Where resource rents are important, assessment should also be made of returns to the holders of these assets. These may be reflected in profits (where ownership is private, for example, oil-companies in times of rising oil prices) or in royalties paid to governments (where the state is also a recipient of resource rents, as in the case of export taxes on Costa Rican bananas)

What this method does not do is to unpack the distribution of earnings within the firm - the average incomes sustained may be a very misleading figure of median incomes. We will consider this issue below.

Figure 38: Calculating returns to all factors in the value chain

Factor	Indicator of distribution	Method of calculation	Data sources
Labour	Incomes sustained	Overall wages and salaries bill divided by numbers of employee hours; to include temporary and part-time workers Repeat procedure with main suppliers and calculate overall average	Balance sheet and financial and personnel functions in the enterprise
Capital	Rates of profit (on net assets or shareholders funds)	Read off balance sheets	Balance sheet and financial and personnel functions in the enterprise
Natural resources	Rates of profit (on net assets or shareholders funds) Royalties	Read off balance sheets Read off official documents	Balance sheets and financial function of the enterprise Government publications; financial function of the firm

14.6 The Locational Dimensions of Income Distribution

The entry point for much value chain analysis is on inter-country distribution of returns, and this, as we have seen, is probably best reflected in the value added and incomes sustained (suitably corrected for exchange rate distortions by either PPP or real exchange rates). However, the nation is not the only geographical unit of account. Others include:

- The supranational region – for example, NAFTA or the EU
- The sub-national region – for example, Central Province in Kenya
- The district within sub-national regions – for example, Kiambu within Central Province in Kenya
- The town and its environs (Limuru in Kiambu District in Kenya)

Each of these are important units of geographical space. But they are not equally easy to research (Figure 38). Nation states and some supranational regions usually have comprehensive data-bases in which the analysis can be pursued. Depending on the degree of federalism, the size of the country and levels of per capita income, there may also be some provincial/state data and district-level data. Few towns, except those in rich countries, provide any useful or comprehensive data to further regional analyses.

Figure 38: Data sources for examining geographical distribution of returns

	Availability of data	Sources of data
Supranational region	Moderate	Representative organisations (e.g. EU); international organisations (e.g. WTO on trade, UNIDO on industry, FAO on agriculture, ITO on telecommunications)
The country	Good	Central Statistical Office publications
The sub-national region	Moderate, better in federal political systems, in large countries and in richer countries	Central Statistical Office publications; state/provincial publications
The district	Poor	Central Statistical Office publications; state/provincial publications
The town	Seldom available, but better in richer countries	Publications of local authorities

14.7 Decomposing income streams - class, gender, ethnicity, and income groups,

If average sustained incomes have the virtue of incorporating returns to all factors, and not just to capital, then they have the disadvantage of hiding disparities between different groups who obtain returns from production. A distributional focus to value chain analysis will place particular emphasis on this decomposition of earnings. Which form of decomposition is used will depend on the distributional lens which is used. But some of the main foci are:

- A functional distribution of income, separating out returns to capital (profits) and labour (wages), bearing in mind the importance of recognising informal economy producers utilising their own limited capital as well as outsourced informal workers.
- A gender distribution, tracing the earnings of women
- An ethnic and caste distribution, for example with regard to the scheduled castes (“untouchables”) in India, blacks in South Africa and ethnic Malays in Malaysia or Fijians in Fiji.

In general, the only data which is likely to be freely available is that which reflects the functional distribution of returns within the formal economy. The other categories – informal economy, gender and ethnicity – almost always require primary research, and in some cases may involve the collection of particularly sensitive data since these divides almost always reflect power relations in the place of work, and the holders of the key information may be particularly reluctant to provide the data. In other cases it may not be a matter of withholding information, but rather than noone collects this data.

Figure 39: Decomposing income returns; first round analysis in the enterprise

Income group	Data required	Data sources
Class: Capital ^a Labour	Annual Profits Annual wage and salary bill	Balance sheet; finance function Wage and salaries from finance function, numbers employed from personnel function
Informal producers Outsourced workers	Income, expenditure Income	Detailed enquiry with producers Detailed enquiry with workers and outsourcing agents, from firm finance and personnel functions
Gender	Earnings per hour	Detailed enquiry with finance and personnel functions
Ethnicity and caste	Earnings per hour	Detailed enquiry with finance and personnel functions

^a In the case where owners are also senior managers, the profit figure should also include the difference between the actual salaries which these owners receive and those they would have had to pay for professional salaried managers.

^b Informal producers/traders incomes from their productive activities fluctuate enormously, hence it may be necessary to collect data over a time period – for example income and expenditure for this week, three weeks ago, three months ago. Furthermore since they seldom make distinctions between expenditure on personal consumption and cost of inputs the researcher has to be creative in gathering and sorting out relevant income and expenditure information.

Enterprise-level enquiries on income distribution are not new. But value chain analysis potentially offers a new and powerful insight into these distributional decompositions, particularly with regard to gender issues. To the best of our knowledge this particular approach to distribution has not been adopted so far. The methodology would entail mapping the (gender) distribution of incomes throughout the chain (Figure 40):

Figure 40: Proposed methodology for looking at the gender distribution of income in the cotton clothing value chain

	Link	Method of calculation	Data sources
↓	Seed firms	Average wage/salary of men and women	Finance function
	Fertilisers, Pesticides	Average wage/salary of men and women	Finance function
	Implements, machinery	Average wage/salary of men and women	Finance function
	Ploughing (small farms)	Gender share of household income multiplied by share of cotton in household income	Primary research
	Planting, cultivating (small farms)	Gender share of household income multiplied by share of cotton in household income	Primary research
	Harvesting (small farms)	Gender share of household income multiplied by share of cotton in household income	Primary research
	Spinning	Average wage/salary of men and women	Finance function
	Weaving	Average wage/salary of men and women	Finance function
	Finishing, dyeing	Average wage/salary of men and women	Finance function
	Apparel manufacture	Average wage/salary of men and women	Finance function
	Freight, handling	Average wage/salary of men and women	Finance function
	Design	Average wage/salary of men and women	Finance function
	Marketing and advertising	Average wage/salary of men and women	Finance function
	Buying	Average wage/salary of men and women	Primary research
	Retailing	Average wage/salary of men and women	Finance function
	2 nd hand stores, charity shops	Average wage/salary of men and women	Primary research
	Recycling	Average wage/salary of men and women	Finance function

Although Figures 39 and 40 provide useful ways of getting into the decomposition of incomes in the value chain, they have the drawback of only focusing on the first-round effects. A more comprehensive focus on distribution will require the analysis to dig deeper, and to assess the distributional consequences of the expenditure by these different groups of employees. Sometimes the results of this type of analysis can provide surprising results. By analogy, for example, one attempt during the 1970s (Berry, 1977) simulated the impact of income redistribution on employment in India, expecting to find that more equal patterns would create more jobs, and thus reinforce a more equal distributional outcome. Instead, what Berry found was that the *marginal* incomes of the rich were spent on (labour intensive) services, whereas the *marginal* incomes of the poor were spent on (capital intensive) industrial products. Similarly, unless we know how the incomes of these various groups in the value chain are spent – and theoretically the 3rd and 4th rounds of expenditures – we will not be able to fully measure the distributional outcomes of value chain activities.

This latter analysis is particularly important if the distributional focus is on income groups – for example, the “very poor”. It is unlikely that these people, predominantly with very little education will be directly employed in value chains feeding into global markets (Wood, 1994). Yet, global value chains may yet affect their lives, perhaps through the incomes which a small region may be generating as a result of the activities of local farms or firms.¹⁸ Or, to offer another somewhat unpleasant example, the prostitutes serving the long-distance truck drivers ferrying products to the ports for export in East Africa (and becoming vectors for the transmission of HIV AIDS) are often drawn from the poorest income groups.

¹⁸ Research being undertaken at the IDS by Neil McCulloch, utilising a regional input-output model in Kenya, is designed to explore these 2nd and 3rd effects of fresh fruit and vegetable producers feeding into global value chains.

15 INCORPORATING A KNOWLEDGE FOCUS INTO VALUE CHAIN ANALYSIS

In earlier sections we have shown that in almost all products, the skill content in production has increased. If we refer back to the cotton clothing value chain in Figure 40 above, for example, it is immediately clear that in virtually every link in the chain, the knowledge content has increased. To take a number of links at random:

- In seed design, advances in biotechnology have led to the development of GMOs which offer significant potential to increase yields and to breed resistance to pests, but involve very heavy investments in R&D
- In implements and machinery production, computer aided design and flexible manufacturing systems, each embodying significant investments of R&D and requiring highly skilled workers, have substituted for manual design and drafting and traditional machine tools
- In finishing and dyeing, new materials are being introduced to treat cotton, most of which embody a significant scientific component; in addition, electronically-controlled equipment (utilising highly trained workers) is being incorporated in finishing houses to control dye-dispensing.
- Marketing and advertising, generally employing graduates, are becoming increasingly important in branding goods and are accounting for a growing share of value chain costs.

Working on the principle of decomposing income returns within the value chain, it is possible to also focus on the distribution of returns to different skills. A value chain decomposition analysis of skilled and unskilled workers can play an important role in charting this changing skill profile, and requires similar forms of analysis and data-collection to those utilised in exploring the gender and ethnic distribution of income. But, in addition, there are two other knowledge-intensive factors which can be usefully incorporated into a value chain analysis:

- Skills are increasingly mobile internationally, partly as a consequence of advances in air-travel, and partly as a consequence of the internet and email. This has made it possible and economic for workers from rich countries who possess scarce design, engineering, production and marketing know-how to co-operate in production with less-skilled workers in poor countries by means of frequent short trips by air, as well as through the use of telecommunication. For example, as Schmitz has shown, the ability of Sinos Valley shoe exporters in Brazil to enter global value chains was made possible by buyers making close contact with them, providing design skills and acting as conduits to the final market (Schmitz, 1995, 2000). Indeed, companies such as NIKE and The GAP do very little of their own production, but add value through their design and marketing skills by intermediating developing country producers into final markets.
- Information technology (IT) is playing an increasingly important role in global production systems (Figure 41). There are a number of components to this,

including the use of IT within and between each chain of the link, where there are an increasing number of applications including CAD (computer aided design), MRP (materials requirement planning for materials flow), ERP (enterprise resource planning for integrated data systems), CIM (Computer integrated manufacturing systems), EDI (electronic data interchange between enterprises), EPOS (electronics point of sales), CRM (customer relationship management) through data-mining (complex analysis of very large data-bases on consumer profiles), and the use of the web (email and e-commerce) both between enterprises as well as in the home. It is possible to categorise the various e-commerce technologies and systems into:

- B2B – business-to-business for supply chain links
- B2C – business-to-consumers for focused retailing
- B2G – business-to-government for links of the enterprise to government.

All of these phenomena can be factored into a value chain analysis to highlight the knowledge content in production (Figure 42). This will provide important insights into the dynamic rents which characterise global value chains, and also into the determination of the theoretical issue as to whether we can identify different forms of value chains (namely buyer- and producer-driven chains) or whether we are instead witnessing a pervasive shift to disembodied, knowledge-intensive processes across all value chains (Part II above). Some of the data is available through an analysis of public data sources, researches into the operations of specialised portals on the www (for example, COVISINT, which is being utilised for B2B transactions in the auto sector, and other sector-specific portals dedicated to forward linkages from producers to buyers, as in horticulture and fish marketing)¹⁹.

¹⁹ This latter phenomenon of specialised portals is the subject of a joint IDS/LSE research project being undertaken by John Humphrey, Robin Mansell and Hubert Schmitz. The role of B2B e-commerce in various value chains is the focus of a research project undertaken by Sagren Moodley and Mike Morris in the School of Development Studies, University of Natal (Moodley 2001a,b).

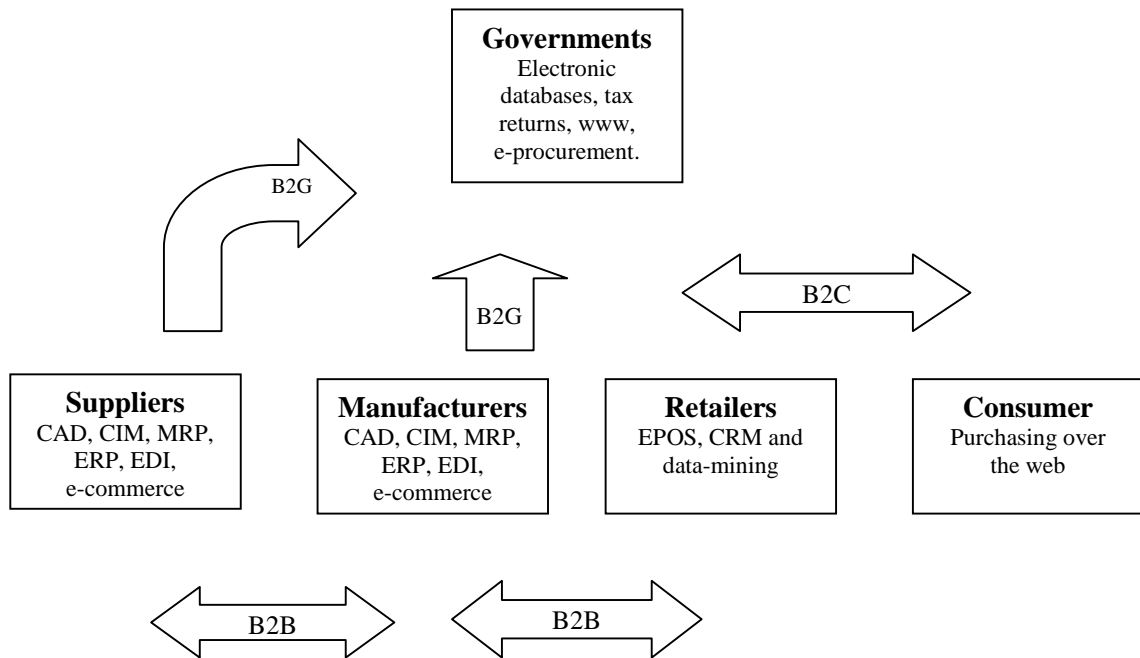
Figure 41: IT in production systems**Figure 42: Analysing knowledge intensity in value chains**

Area of knowledge focus	Subject of analysis	Data source
<i>Skilled and unskilled workers</i>	Numbers, division of labour and rewards of different labour skills in each link in the chain	Finance and HR functions in the enterprise
<i>International mobility of skills and knowledge</i>	<ul style="list-style-type: none"> <input type="checkbox"/> Mobility of skilled personnel (number and nature of visits) <input type="checkbox"/> Division of labour around skills in the value chain <input type="checkbox"/> Use of email and the internet 	<ul style="list-style-type: none"> <input type="checkbox"/> Public data sources on travel <input type="checkbox"/> Interviews with various functions in enterprises throughout the chain <input type="checkbox"/> Use of www
<i>Use of IT in value chains</i>	<ul style="list-style-type: none"> <input type="checkbox"/> Inventory and analysis of use of IT within each link in the chain <input type="checkbox"/> B2B links <input type="checkbox"/> B2C <input type="checkbox"/> B2G 	<ul style="list-style-type: none"> <input type="checkbox"/> Interviews with IT function and production control in enterprises <input type="checkbox"/> Sales and purchasing functions; analysis of specialised web-portals <input type="checkbox"/> Sales function; analysis of specialised web-portals <input type="checkbox"/> Finance function

16 HOW DO SMEs FIT INTO GLOBAL VALUE CHAINS?

One of the concerns often expressed in development policy is the way in which small firms can be integrated into global value chains. Occasionally SMEs are a focus of interest in their own right – for example, because they are considered to be wellsprings of innovation, or to embody agility. But, more often, the focus on SMEs is a way of getting into some of the distributional issues raised in the previous discussion, since in general they are associated with poor people (especially when microenterprises are involved), poor regions and poor ethnic groups (for example, black business development in South Africa). So, where there is a focus on distributional issues, there may be better ways of getting into the determinants of income distribution by focusing more directly on the recipients of income than on SMEs. On the other hand, since individuals generally receive income through their participation in institutions (particularly in producing enterprises), SME development can be an important vehicle for policy delivery.

In analysing the role which SMEs can play in global value chains, the following procedure may be productive (we do not cover the specific problems encountered by microenterprises in this discussion). Many SMEs tend not to be incorporated in global value chains, and insofar as they do they are dealt with in more detail in the Manual prepared by McCormick and Schmitz (2001).

- How are SMEs to be defined? There is a loose convention that microenterprises involve the employment of less than 5 (and sometimes 10) people, small firms more than 20 and less than 50 (sometimes 100), and that medium-sized enterprises will generally employ more than 50 (sometimes 100) and less than 500 (sometimes 1,000) people. But not only will these employment-size categories vary between countries, but often employee numbers may be a poor reflection of size. This is particularly true in the high-tech sector where manufacturing is subcontracted out, and design houses employ few people, but have very high levels of value added. In some countries, such as India, some recognition of this occurs by including capital values in the definition of “small scale”, but although this can be helpful in some contexts, in knowledge-intensive sectors it is human-capital rather than fixed-capital which represents the major body of investments. Methodologically, therefore, in each value chain study it is important to bear in mind that:
 - Size is a relative concept, and can best be understood in relation to the nature of each value chain
 - Size may be reflected in the number of employees, the turnover, or the value of fixed capital or a combination of these
- Having decided what constitutes “smallness” in the context of a particular value chain, or a particular link in the value chain, the next step is to map the size distribution of participating firms. Most countries’ industrial censuses include this data in relation to number of employees (but less seldom in relation to size of capital or turnover), but these datasets may be out-of-date or have poor coverage, in which case primary research may be required. They also generally apply to

plant size rather than enterprise size. As part of this mapping exercise, the share of SMEs can be computed through the use of 2-, 5- or 10 firm concentration ratios or pareto diagrammes (for a discussion of these techniques see the earlier section on accessing final markets), using whatever indicator of size is deemed most appropriate.

- The next step is to try and benchmark the strengths and weaknesses of SMEs. Using the suggested methodology described in the discussion in previous sections, it may be possible either to compare SMEs against each other (getting some sense of the spread of efficiency within this group of enterprises) or to compare them against larger enterprises. Ideally the benchmarking should also include the capacity of these SMEs to also hear their markets effectively (Chapter 11 above).
- A key strength of value chain analysis is that it highlights the systemic interconnectedness of individual enterprises and links in the chain. SMEs can be interconnected in two main ways, either horizontally (with other SMEs, producing similar products) or vertically in value chains (Figure 43). The analysis needs to chart this mode of SME insertion into the value chain and to show the nature of these interconnections, particularly with regard to horizontal links. Schmitz's heuristic dual distinction between links which are enterprise-to-enterprise and those which are enterprise-to-many-enterprises, and links which are vertical (up and down the chain) and those which are horizontal, is a helpful way of classifying these systemic value chain links.

Figure 43: A framework for thinking about SME inter-firm linkages

	Bilateral	Multilateral
Horizontal links		
Vertical links		

Source: Schmitz (1998)

- Complementary to the analysis of the share of SMEs in production, the analysis should also address distributional issues. As in the earlier discussion, this should focus both on the profitability and incomes sustained by SMEs as a group (comparing these to medium and large firms), but also to intra-enterprise distribution.
- As we have seen in earlier analysis, a second key strength of value chain analysis is that it throws light on the manner in which producers are connected to global markets. This is particularly the problem for SMEs, since by their size, they are required to sell through intermediaries. (By contrast, large firms can sell directly to a retailer, and subsidiaries of TNCs feed into their global production systems). These buying networks can often be very complex, sometimes involving a number of parties – for example, local buyers, importing wholesalers, or TNCs (for many years Hindustan Lever in India exported products made by SMEs). These intermediaries may not only siphon off much of the profit in a value chain, but may play an important role in enabling or blocking the capacity of SMEs to upgrade.

- International experience suggests that a key factor underlying the capacity of SMEs to insert themselves effectively into global value chains is when they combine to engage in various forms of joint action. There are a variety of forms of joint action which might include:
 - Lobbying government for assistance
 - Undertaking joint activities, such as quality auditing (for example, in the case of surgical instruments in Pakistan - Nadvi, 1999), branding (as in the case of many small Italian clothing and footwear firms – Best, 1990), and especially with regard to learning-networks (Barnes, 1999; Bessant and Tsekouras 2001; Morris 2001).
- As we saw in earlier sections, entry into global markets is increasingly being governed by a series of “rules” set by private parties, rather than by governments through trade policies. These private rules include quality and environmental standards, and increasingly also labour standards. In each case, elaborate new procedures have been developed, which require firms to document their activities in great detail. This has proven to be a problem for SMEs, even in high income countries. The outcome of this development is that SMEs will find it increasingly difficult to participate in global value chains, since in most cases these value chains have at their apex large firms who are required to meet these standards due to public pressure (for example, environmental and labour standards), and who also frequently find that these standards assist their efficiency (for example, quality standards). Researching the impact of this important issue on SMEs requires not only investigation in SMEs themselves (do they see these pressures emerging? what have they done about it?), but also with their buyers (are they concerned that SMEs will be able to meet these standards? has this diminished their desire to use SME suppliers? are they taking steps to upgrade these small suppliers?)
- SMEs in developing countries often find themselves in a double bind through participating in global value chains. Global governance has introduced a process of *homologation* (that is the application of uniform global rules and standard conformance requirements with respect to issues such as quality measures, specific material grades, environmental standards, adoption and application of ICT systems etc.) governing the integration of SMEs into value chains. However SMEs, particularly in developing countries suffer from a real technology deficit in the broad sense. So although the globalisation of value chains offers the real possibility of linking into more profitable export markets and opens up the potential for serious upgrading, developing economy SMEs often simply do not have access to the necessary resources, equipment, materials and professional management skills to meet these conformance requirements which require them to operate at a level beyond their local environment. For example, the costs of obtaining ISO accreditation are generally invariant with respect to firm-size, and thus tend to disadvantage SMEs.
- The impact of globalisation on SMEs in developing countries is thus ambiguous.. On the one hand it opens up opportunities for SMEs in developing countries to

benefit from integrating into global value chains. On the other, it simultaneously raises the barriers to entry into these global value chains, particularly at the starting up phase. Global value chains are defined by developed economy standards and even those SMEs not exporting but supplying to firms that are doing so (and who are thus an intrinsic part of global value chains) find themselves being disciplined by external protocols. The general impact of this process is to force a bifurcation in the developing world as well as within developing economies. The knock on effect of those firms that are able to make the transition is a general upgrading of standards and processes throughout the developing economy or sector, whilst those that are not able to meet these conformance standards find themselves rapidly left behind and excluded with consequent major income and distributional impacts. A methodological consequence of this process for value chain analysis is the need to analyse the life cycle of developing country SME integration in particular global value chains, measuring local firm participation over time, not only in terms of number and rate of participation, but also their particular place in the value chain under examination.

Figure 44: A procedure for looking at the role of SMEs in global value chains

Sequence of enquiry	Issue to be addressed	Data sources
Definition of “small” in each value chain	Number of employees Turnover Fixed capital	National and sectoral census data; survey of enterprises
Size distribution	Share of output/employment Concentration ratios Pareto analysis	National and sectoral census data; survey of enterprises
Benchmark	Practices and performance Ability to hear the market	Enterprise level analysis, of both SMEs and medium/large firms; interviews with buyers
Nature of connectedness	Horizontal and vertical links Bilateral and multilateral links	Interviews with SMEs and with buying firms
Distributional issues	SME share of value chain returns Distribution within SMEs	Value chain interviews – see previous discussion on distribution
Connection to markets	Destination of the sales of SMEs, through various intermediate layers	Value chain interviews as well as interviews with SMEs
Collective efficiency	Extent and nature of links with other SMEs	Interviews with other SMEs and with Business Associations and government officers
Capacity of SMEs to cope with new rules of entry into global markets	ISO standards; other industry-specific standards (eg HACCP in food industry); labour standards, etc.	Interviews with SMEs, with service providers assisting SMEs, and with buyers along the chain
Life cycle of SME integration	Number of firms over time, rate of change, movement up or down value chain	Interviews with lead sourcing firm/agents, SMEs and their suppliers.

17 CONCLUSION AND POLICY IMPLICATIONS

Much of what has been written in the previous pages is imbued with policy implications. In drawing together the major policy conclusions we will therefore not simply relist many of the policy relevant points made throughout the Handbook. Moreover, policy analysis is always contingent to place and time. Hence in this final section we draw together some of the policy threads by way of a conclusion, and point the reader to the key policy issues that can be considered as a consequence of value chain analysis.

One of the fundamental underpinnings of the new global integration is the stress on knowledge intensity and the utilisation of information in economic activity. Within nearly all forms of productive activity the importance of intangible activities and elements in value chains have been increasing and there has been a shift in importance away from the tangible aspects of production towards the more intangible. This is represented by a shift of costs and rents from the transformation of tangible goods to intangible goods; the latter creating its own specific barriers to entry. Hence the labelling (by influential writers such as Castells) of this new economic era as the ‘new information economy’ (Castells, 2000 vol 1&3).

This has manifested itself within global value chains in a loosening up with respect to control, location and the function of responsibility for tangible and intangible activities. There has been a clear movement away from large vertically integrated operations which internalised all functions and activities (tangible as well as intangible) within one corporation to the externalisation of ownership of activities/actors/functions and their dispersal to smaller firms operating far and wide globally. As this has proceeded apace in the last decade there has also been a loosening of coordination, management and upgrading responsibilities which have shifted away from the lead firms. As a result this has also externalised the role of supply chain management and hence supply chain learning, placing some of the responsibility on other actors (including developing country governments) in the value chain.

One of the implications of industrial activity becoming globally dispersed has been a shift in the sphere of competence of some developing economies. A consequence of this is the emergence of a fundamental re-division of the world dependent on the ability of various country economies to integrate knowledge intensive activities and to operate effectively within the new information parameters. There has been an international shift in the social and economic division of labour between industrially developed countries, middle income industrialising countries, and poor developing countries. Intangible activities/functions found for example in design, R&D, branding, marketing, logistics, financial services etc have become concentrated in the industrially developed countries. The process of production (i.e. the tangible activities involved in transforming goods) on the other hand has increasingly become contracted out to a large band of middle income developing countries (China, India, Mexico, South Korea, Singapore, etc) exhibiting highly developed process manufacturing competence as well as a range of countries able to produce cheap components on the basis of low wages. New divisions have thus occurred within the developing world based on the ability of some countries to become more adept and successful at integrating firms and other forms of productive activity into global value

chains; whilst others have depended upon constantly decreasing costs as the basis of attaining global competitive advantage.

Hence within the developing world there has been a hierarchical reconfiguration of various countries. In some of these middle income countries at the apex of the developing world, some firms and parts of sectors have been able to shift functions away from the more tangible aspects of production and gain control over the more profitable functions of branding and marketing (moving into own branded manufacturing); or through contract manufacturing to play a coordinating logistical function and reap the fruits of controlling the barriers to entry in certain value chains. Others have been able to concentrate on domestic manufacturing but, as a result of absorbing highly developed knowledge intensive process skills, stay in those parts of their global value chains where competitive edges are based on factors other than price (for example quality, lead times, delivery reliability etc). Taking advantage of the insistence of lead firms for the standardisation of product and process specification and the generalisation of such parameter enforcement throughout the value chains, this range of countries have shown they are quite capable of undertaking production activities at levels close, or equal, to those of the industrialised countries. As the need and prevalence of lead firms governance over upgrading has decreased, and responsibility for ensuring competence in production process skills has shifted to other domestic agents and functions – e.g. to national systems of innovation, local consultants, external intermediaries, business associations - this band of middle income countries has been able to internalise competence upgrading at the firm, sector and country level. They have consequently been able to take advantage of these global processes. Through the active upgrading of these domestic functions, they have ensured that they are as little dependent on low wages for comparative advantage as possible, hence avoiding immiserising industrial growth. As a result these countries have witnessed increasing income levels and a decline in absolute and relative poverty levels.

Another band of developing economies (like Bangladesh or the Dominican Republic) have been able to integrate into global value chains primarily through focussing on part of the tangible aspects of production, entering into subcontracting relationships within various value chains. However they have primarily done so on the basis of price competition dependent on an ever ready supply of cheap labour working for globally low wages. Locked into an immiserising growth path it is still a moot point whether they have benefited from this process of global integration. It is not at all clear that the gains of globalisation have spread much or widely over their frontiers. Yet notwithstanding this, they would still seem to be better off than a range of countries that seem destined to be permanently excluded from this process of global integration. Countries (like Afghanistan or Somalia) that have not been able to integrate into the global economy at all, or (like Zimbabwe) which once seemed to demonstrate the contrary but are now seemingly locked into a desperate and downward spiral of exclusion.

Value chain policy analysis is constantly cognisant of the dangers of falling into these two latter bands of developing countries. The policy conclusion that this gives rise to reinforces the basic assumption underlying this Handbook: If the issue is not *whether* one engages in globalisation but *how*, then where should one place the policy emphasis to ensure that how one engages with spreads the gains from globalisation?

Fundamentally in this new order, a country's ability to generate highly skilled competencies and skilled personnel becomes its greatest asset in being able to positively integrate into global value chains, to gain control over new competencies and shift functions and places within a value chain, to create barriers to entry, and finally, to ensure upward income distribution through successful participation in such value chains. This implies that the spatial and vertical distribution of profit and incomes within global value chains should be viewed as indicators of barriers to entry and acquisition of assets rather than as unequal (i.e. unfair) exchange or unfair appropriation of profit by leading firms. For where developing countries, economies, firms, and regions are located in this new global re-differentiation makes a huge difference to the lot of ordinary people. In short, being located in high value adding segments means that higher rents are appropriated by virtue of this location, and are concomitantly distributed widely through higher incomes accruing to those who work in such firms and sectors.

From a value chain policy perspective this requires thinking in dual terms. The first is by seeking to derive positive policies from the analysis of a country or sector's involvement in a particular value chain in order to pursue upgrading possibilities at the macro, meso and micro levels. But secondly, and simultaneously, it requires formulating defensive policy strategies in order to ensure some measure of protection for the poor against the negative implications of globalisation.

Hence value chain analysis stresses the different modalities of upgrading. From a policy perspective, to reiterate some of the lessons from previous pages, upgrading can occur in a number of ways and be facilitated through a number of interventions. Firms can be assisted to acquire new competencies and take on activities or functions associated with being located elsewhere in the value chain (which may or may not mean acquiring control over new intangible activities). Governments can facilitate firms (either individually or through sharing collectively in the process) to upgrade their knowledge intensive process competencies. Firms can shift into other sectors/value chains as a result of the acquisition of new competencies. Upgrading can be the result of the diffusion of management/skilled worker skills as personnel migrate from firms located in sectors/value chains where supply chain learning has been strong to jobs in other sectors/value chains. This will bring the knowledge intensive upgrading process to practically bear on their new firms. Government can foster the resource development and capacity expansion of the national system of innovation to raise the general knowledge intensive environment from which firms draw their resources and within which they operate.

Although measures to assist upgrading are the key policy conclusion of the Handbook, it is as well to note that policy implications can work in different directions. Value chain analysis does not in any sense imply that firms, countries and peoples are marching down a one-way upgrading street. There are negative policy implications as well as positive ones, and this reconfiguration of the global order in the developing world is itself subject to processes of change. For downgrading can also occur as a result of firms getting locked into global value chains which obstruct the acquisition of intangible competencies. Governments can simply ignore the need to foster knowledge intensive activities and skills, or they may be utterly unable to do as a result of a thorough lack of capacity. Alternatively, despite all the best

intentions in the world, other factors like spiralling crime, AIDS pandemics and social instability, outside the ambit of industrial policy can intervene, resulting in the skilled personnel so necessary for a shift towards an upgrading path emigrating to other countries and not being able to be replaced, hence depleting the country's skilled pool of necessary competencies.

Finally, the policy lens in this Handbook has been on measures designed to directly assist the upgrading of the productive sector. But this is not the only domain of policy which affects upgrading. Overall macroeconomic management has a role to play – for example, without a stable and realistic currency, there may be little incentive for the productive sector to enhance its capabilities. Similarly, the productive sector will require access to an educated and skilled labour force, realistic policies to encourage investment, appropriately defined corporate and property laws and so on. The achievement of sustained income growth is thus an outcome determined by a range of policy interventions, backed by a social and political compact which favours sustained and stable accumulation.

REFERENCES

- Automotive World, London.
- Bairoch P. and R. Kozul-Wright (1996), "Globalization Myths: Some Historical Reflections on Integration, Industrialization and Growth in the World Economy", UNCTAD Discussion Papers No 13 March, Geneva.
- Barnes J. and R. Kaplinsky (2000), "Globalisation and the death of the local firm? The automobile components sector in South Africa", Regional Studies, Vol. 34, No. 9, 2000, pp. 797-812., 2000.
- Barnes J. and M. Morris (1999), "Improving operational competitiveness through firm-level clustering: A case study of the KwaZulu-Natal Benchmarking Club", Presented at International Conference: Responding to Challenges of Globalisation: Local and Regional Initiatives to Promote Quality Employment through Social Cohesion, May, Bologna.
- Barnes, J. (1999), "What chances operational competitiveness in the South African Automotive Components Industry?: Evidence From an International Benchmark Operation", Research Report 20, School of Development Studies, University of Natal, Durban.
- Barnes J, (2000), "Domestic Market Pressures Facing the South African Automotive Components Industry", Research Report No. 33, School of Development Studies, University of Natal, Durban.
- Bernstein, H. (1996) "The Political Economy of the Maize *Filiere*", Journal of Peasant Studies, Vol 23, No 2/3.
- Berry R. (1977), Inequality, Demand Structure and Employment: The Case of India, D Phil Dissertation, University of Sussex, Brighton.
- Bessant J. (1991), Managing Advanced Manufacturing Technology, London, Basil Blackwell.
- Bessant J and Tsekouras G (2001), "Developing learning networks" A.I. and Society, 15(2): p. 82-98.
- Best M. H. (1990), The New Competition, Oxford, Polity Press.
- Brown S, J. Bessant and R. Lamming (2000), Strategic operations management., Oxford: Butterworth Heinemann.
- Castells M. (2000), The Information Age: Economy, Society and Culture, Oxford, Blackwell.
- Canadian National Framers Union (2000), The Farm Crisis, EU Subsidies, and Agribusiness Market Power, Report presented to Senate Standing Committee on Agriculture and Forestry, Ottawa: February 17 2000
- de Meyer A, H. Katayama and J. S. Kim, (1996), "Building Customer Partnership as a Competitive Weapon?: The Right Choice for Globalising Competition", Report on the 1996 Global Manufacturing Futures Survey, Boston University, 1996.
- Dicken P (1998) Global Shift: Transforming the World Economy, Paul Chapman, London.
- Dolan, K. C. and J. Humphrey (2000), "Value chains and upgrading: The impact of UK retailers on the fresh fruit and vegetables industry in Africa", Journal of Development Studies, Vol. 37, No. 2, pp. 147-176.
- Evans, P. and T. Wurster (2000), Blown to bits: How the new economics of information transforms strategy., Cambridge, Mass.: Harvard Business School Press.

- Feenstra R. C. (1998), 'Integration of Trade and Disintegration of Production in the Global Economy', Journal of Economic Perspectives, Vol. 12, No. 4, pp.31–50.
- Förster, M. and M. Pearson (2000), "Income Distribution in OECD Countries", Paper Prepared for OECD Development Centre Workshop on Poverty and Income Inequality in Developing Countries: A Policy Dialogue on the Effects of Globalisation, Paris
- Freeman, C. (1976), The Economics of Industrial Innovation, London: Penguin Books.
- Gereffi, G. (1994), "The Organization of Buyer-Driven Global Commodity Chains: How U. S. Retailers Shape Overseas Production Networks", in G. Gereffi and M. Korzeniewicz (eds.), Commodity Chains and Global Capitalism, London: Praeger.
- Gereffi, G. (1999a), "International Trade and Industrial Upgrading in the Apparel Commodity Chain", Journal of International Economics, Vol. 48, No. 1, pp 37-70.
- Gereffi, G. (1999b), "A commodity chains framework for analysing global industries", in Institute of Development Studies, 1999, "Background Notes for Workshop on Spreading the Gains from Globalisation, www.ids.ac.uk/ids/global/conf/wkscf.html
- Gereffi, G. (2001), "Shifting Governance Structures in Global Commodity Chains, with Special Reference to the Internet", American Behavioral Scientist, Vol. 44, No. 10, pp. 1616-1637.
- Gereffi, G., M. Korzeniewicz and R. P. Korzeniewicz (1994), "Introduction", in G. Gereffi and M. Korzeniewicz (eds.), Commodity Chains and Global Capitalism, London: Praeger.
- Gereffi, G and M. Korzeniewicz (eds.) (1994), Commodity Chains and Global Capitalism, London: Praeger.
- Gereffi, G., R. Garcia-Johnson and E. Sasser (2001), "The NGO-Industrial Complex", Foreign Policy, July-August, pp. 56-67.
- Gereffi, G. and R. Kaplinsky (eds.) (2001), "The Value of Value Chains", IDS Bulletin, Vol. 32, no 3.
- Gereffi, G. (ed) (2002), Who Gets Ahead in the Global Economy? Industrial Upgrading, Theory and Practice, New York: Johns Hopkins Press.
- Gibbon, P. (2001), "Upgrading primary production: A Global Commodity Chain Approach", World Development, Vol. 29, No. 2, pp 345-364.
- Gibbon P. (2002 forthcoming) "Back to the basics' through delocalization: The Mauritian garment industry at the end of the twentieth century" in G. Gereffi (ed.), Who Gets Ahead in the Global Economy? Industrial Upgrading, Theory and Practice, New York: Johns Hopkins Press.
- Hamel, G. and C. K. Prahalad (1994), Competing for the Future, Cambridge: Harvard Business School Press.
- Hummels D., Jun Ishii and Kei-Mu Yi (1999), "The Nature and Growth of Vertical Specialization in World Trade", Staff Reports Number 72, New York: Federal Reserve Bank of New York.
- Humphrey, J., R. Kaplinsky and P. Saraph (1998), Corporate Restructuring: Crompton Greaves and the Challenge of Globalisation, N. Delhi: Sage Publications Ltd.
- Humphrey, J. and H. Schmitz, (2001), "Governance in Global Value Chains", in G. Gereffi and R. Kaplinsky (eds.), IDS Bulletin, Vol. 32, No. 3.

- Humphrey, J. and H. Schmitz (1996), "The Triple C Approach to Local Industrial Policy", World Development, Vol. 24, No. 12, pp. 1859-1877.
- IDS/UNDP (1992), A Industrial Strategy for the Dominican Republic, Institute of Development Studies, Brighton, University of Sussex.
- Industrial Restructuring Project (2000), "Helping firms to hear their markets", Policy Briefing Paper No 1, Durban: School of Development Studies, University of Natal.
- Industrial Restructuring Project (2000), "Implementing World Class Manufacturing" Policy Briefing Paper No 2, Durban: School of Development Studies, University of Natal.
- Industrial Restructuring Project (2000), "Supply Chain Management" Policy Briefing Paper No 3, Durban: School of Development Studies, University of Natal.
- Industrial Restructuring Project (2000), "Benchmarking" Policy Briefing Paper No 5, Durban: School of Development Studies, University of Natal.
- Johnson, H.T. and R.S. Kaplan (1987), Relevance Lost, Boston, Harvard Business School Press.
- Kaplan, D. E. and R. Kaplinsky (1998), "Trade and Industrial Policy on an Uneven Playing Field: The Case of the Deciduous Fruit Canning Industry in South Africa", World Development, Vol. 27, No.10, pp. 1787-1802.
- Kaplinsky R (1993), "Export Processing Zones in the Dominican Republic: Transforming Manufactures into Commodities", World Development, Vol. 22, No. 3, pp. 1851-1865.
- Kaplinsky, R. (1994), Easternisation: The Spread of Japanese Management Techniques to Developing Countries, London: Frank Cass.
- Kaplinsky R (1998), "Globalisation, Industrialisation and Sustainable Growth: The Pursuit of the Nth Rent", Discussion Paper 365, Brighton: Institute of Development Studies, University of Sussex.
- Kaplinsky R (2000), "Spreading the gains from globalisation: What can be learned from value chain analysis?", Journal of Development Studies, Vol. 37, No. 2., pp 117-146
- Kaplinsky, R. (2002, forthcoming), "Gaining From Global Value Chains: The Search For The Nth Rent", in G. Gereffi (ed.), Who Gets Ahead in the Global Economy? Industrial Upgrading, Theory and Practice, New York: Johns Hopkins Press.
- Kaplinsky R. and C. Manning (1999), "Concentration, competition policy and the role of small and medium sized enterprises in South Africa's Industrial Development", Journal of Development Studies, Vol. 35, No. 1, pp. 139-161.
- Kaplinsky, R. and J. Readman (2000), "Globalisation and Upgrading: What can (and cannot) be Learnt from International Trade Statistics in the Wood Furniture Sector?", mimeo, Brighton, Centre for Research in Innovation Management, University of Brighton and Institute of Development Studies, University of Sussex
- Hymer S (1975), "The Multinational Corporation and the Law of Uneven Development", in H Radice (ed), International Firms and Modern Imperialism, London, Penguin.
- Lee, J. and J. Chen (2000), "Dynamic Synergy Creation with Multiple Business Activities: Toward a Competence-based Growth Model for Contract Manufacturers", in R. Sanchez and A. Heene (eds.), Research in Competence-based Research, Advances in Applied Business Strategy Series, Vol. C, JAI Press.

- Leonard-Barton, D. (1995), Wellsprings of Knowledge, Cambridge: Harvard Business School Press.
- Lundvall, B. A. (1992), National Systems of Innovation, London: Frances Pinter.
- Maddison, A., (1995), Monitoring the World Economy 1820-1992, Paris: OECD
- Martinussen, J. (1995), Elements of success in cluster policies : from a practitioner's point of view, Worcester: Business Net Ltd.
- McCormick, D. (2001), "Manual for Value Chain Research on Homeworkers in the Garment Industry", mimeo, Institute of Development Studies, Nairobi and Sussex.
- Moodley S (2001a) "Internet-Enabled Supply Chain Integration: Prospects and Challenges for the South African Automotive Industry", Development Southern Africa, forthcoming.
- Moodley, S. (2001b), "The Prospects and challenges of E-Business for the South African Automotive Components Sector: Preliminary Findings from two Benchmarking Clubs", Paper presented to OECD Development Centre/SDIC University of Bologna Conference on "E-Commerce for Development: Reviewing Early Experiences, Comparing New Ideas", Bologna, May.
- Morris M. (2001), "Creating Value Chain Co-operation", in G. Gereffi and R. Kaplinsky (eds.), IDS Bulletin, Vol. 32, No. 3.
- Nadvi, K. (1999), "Collective Efficiency and Collective Failure: The Response of the Sialkot Surgical Instrument Cluster to Global Quality Pressures", World Development Special Issue on Industrial Clusters in Developing Countries, Vol. 27, No. 9, pp. 1605-1626.
- Nelson R. R. (1993), National Innovation Systems: A Comparative Analysis (New York, Oxford University Press.
- Piore M. J. and C. Sabel (1984), The Second Industrial Divide: Possibilities for Prosperity, N York, Basic Books.
- Porter M. E (1985), Competitive Advantage: Creating and Sustaining Superior Performance, N. York: The Free Press.
- Pyke F, and W. Sengenberger (eds), (1992) Industrial Districts and Local Economic Regeneration, Geneva, ILO.
- Raikes P., M. Friis-Jensen and S. Ponte (2000), "Global Commodity Chain Analysis and the French *Filière* Approach", Economy and Society, 29, 3, August, Routledge.
- Ricardo, D. (1817), The Principles of Political Economy and Taxation, London: Dent (Reprinted 1973).
- Sako, Mari (1992), Prices, Quality and Trust: Inter-firm Relations in Britain and Japan, Cambridge Studies in Management 18, Cambridge: Cambridge University Press.
- Saxenian, Annalee (1996), Regional Advantage, Cambridge, Mass: Harvard University Press.
- Schmitz, H. (1995), "Small Shoemakers and Fordist Giants: Tales of a Supercluster", World Development, Vol. 23 No. 1, pp. 9-28.
- Schmitz, H. (1998) 'Collective efficiency and increasing returns', Cambridge Journal of Economics, Vol. 23, No. 4, pp 465-483.
- Schmitz, H (2000), "Global Competition and Local Cooperation: Success and Failure in the Sinos Valley, Brazil", World Development Special Issue on Industrial Clusters in Developing Countries, Vol. 27, No. 9, pp. 1627-1650.
- Schmitz, H. and P. Knorringa (2000), "Learning from global buyers", Journal of Development Studies, Vol. 32 No. 7, 177-205

- Schonberger, R J, (1986) World Class Manufacturing: The Lessons of Simplicity Applied, New York: The Free Press.
- Schumpeter J (1961), The Theory of Economic Development, Oxford: Oxford University Press.
- Semlinger, K. (1995), "Public Support for Firm Networking in Bad-Württemberg", in L. E. Andreasen, B. Coriat, F. den Hertog and R. Kaplinsky (eds.), Europe's Next Step: Organisational Innovation, Competition and Employment, London: Frank Cass.
- Sengenberger W and Pyke F (eds) (1992), Industrial Districts and Local Economic Regeneration, Geneva, ILO.
- Stevens, C and J. Kennan, (2001), "Food Aid and Trade", in S. Deveraux and S. Maxwell (eds.), Food Security in Sub Saharan Africa, London: ITDG Publishing
- Stevens, C. and J. Kennan (2001), "Post-Lome WTO-Compatible Trading Arrangements", Economic Paper No 45, London: Commonwealth Secretariat.
- Teece, D., and G. Pisano (1994), "The dynamic capabilities of firms: an introduction", Industrial and Corporate Change, 3, pp 537-556.
- UNDP (2000), Human development Report, New York, United Nations
- Wade, R. H. (2001), "Is globalisation making world income distribution more equal?", LSE DSI Working Paper Series, No. 01-01. London: LSE Development Studies Institute.
- Womack, J. P. and D. T Jones (1996), Lean Thinking: Banish Waste and Create Wealth in Your Corporation, N. York: Simon & Schuster
- Wood A. (1994), North-South Trade, Employment and Inequality: Changing Fortunes in a Skill-Driven World, Oxford: Clarendon Press.
- Wood, A. (1997), 'Openness and wage inequality in developing countries: the Latin American challenge to East Asian conventional wisdom', World Bank Economic Review, Vol. 11 no 1: 33-57
- Wood, A. (2001), "Value Chains: An Economist's Perspective", in G. Gereffi and R. Kaplinsky (eds.), IDS Bulletin Special Issue on The Value of Value Chains, Vol. 32, No. 3, pp. 41-6.
- World Bank, www.worldbank.org/html/extdr/pb/globalization/papers1
- World Bank, World Development Indicators.

www.advertisingadage.com
www.ids.ac.uk/global
www.kznbenchmarking.co.za
www.nu.ac.za/csds